



SUPPLIER
OF SECTORAL
LEADERS

Sektör Liderlerinin
Tedarikçisi

FURNITURE PROFILES

Mobilya
Profilleri

2020/1

 **Formal** Alüminyum

Kulp profilleri

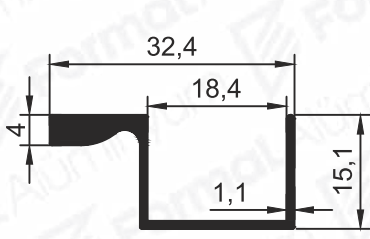

Pr.No: 1917
0,245 kg/m

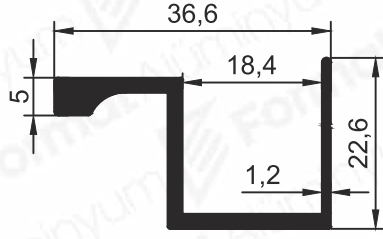

Pr.No: 9873
0,411 kg/m

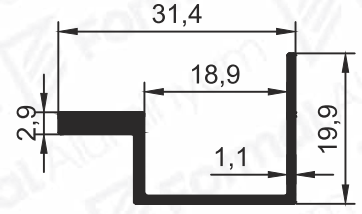

Pr.No: 1630
0,240 kg/m

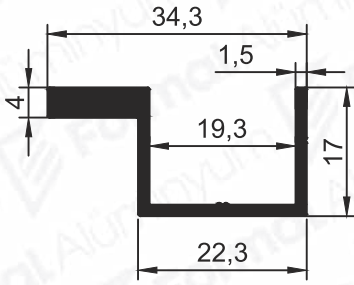

Pr.No: 1440
0,347 kg/m

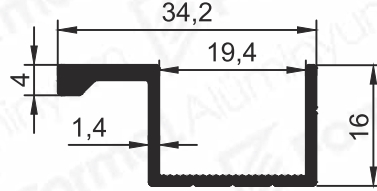

Pr.No: 1657
0,273 kg/m

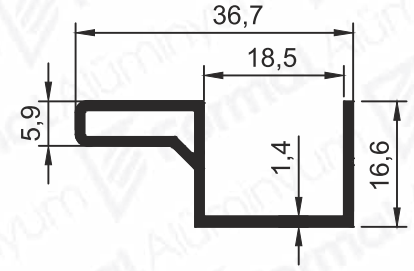

Pr.No: 1459
0,294 kg/m

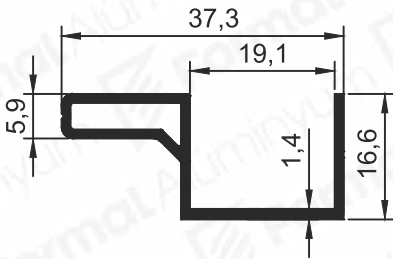

Pr.No: 1600
0,295 kg/m

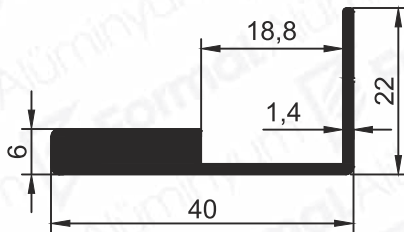

Pr.No: 2230
0,477 kg/m

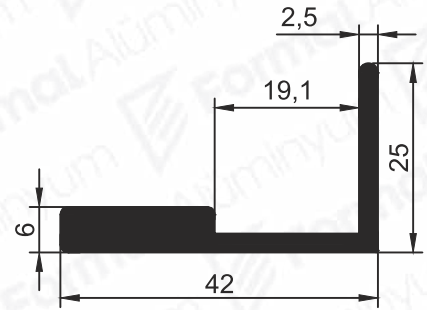

Pr.No: 1474
0,627 kg/m

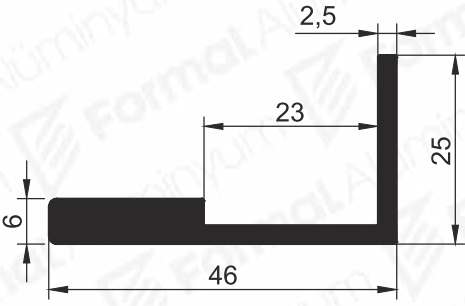

Pr.No: 1496
0,657 kg/m

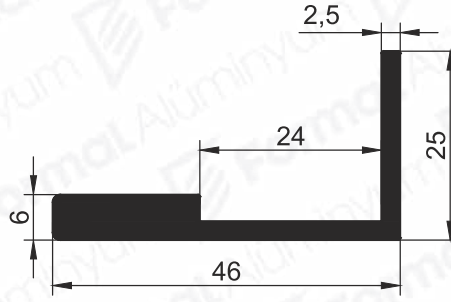

Pr.No: 1577
0,648 kg/m

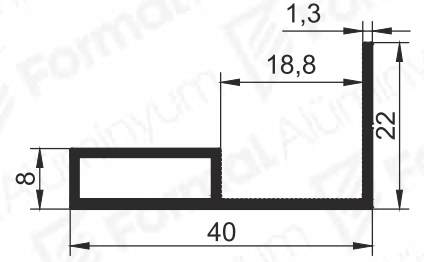

Pr.No: 1890
0,304 kg/m

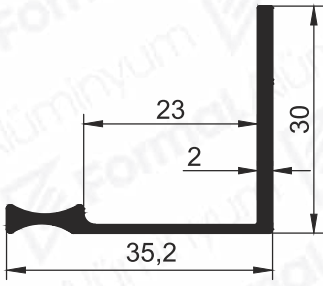

Pr.No: 1631
0,295 kg/m

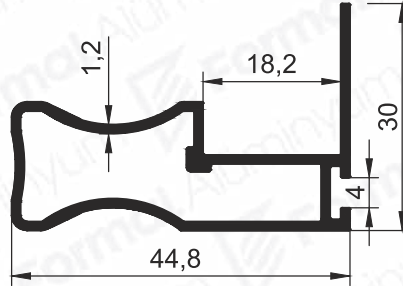

Pr.No: 8937
0,488 kg/m

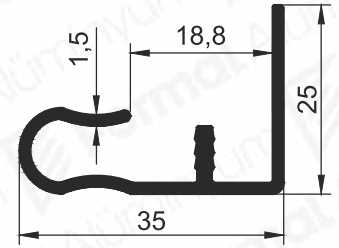

Pr.No: 9186
0,359 kg/m

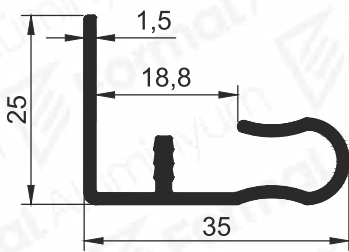

Pr.No: 8769
0,360 kg/m

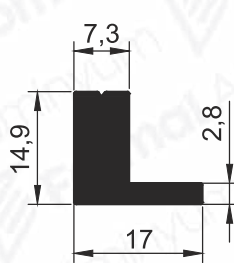

Pr.No: 9330
0,367 kg/m

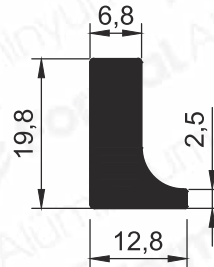

Pr.No: 9978
0,423 kg/m

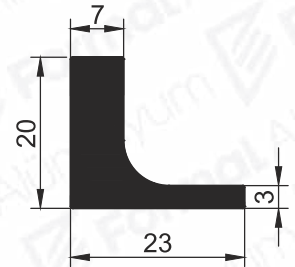

Pr.No: 9433
0,530 kg/m

Y Kulp

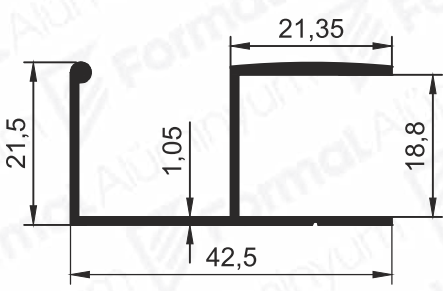

Pr.No: 1789
0,320 kg/m

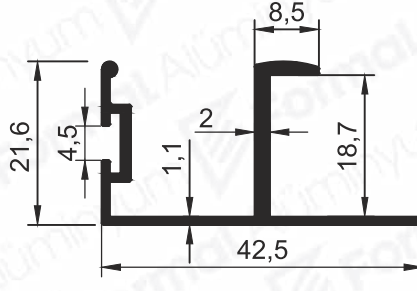

Pr.No: 1967
0,363 kg/m

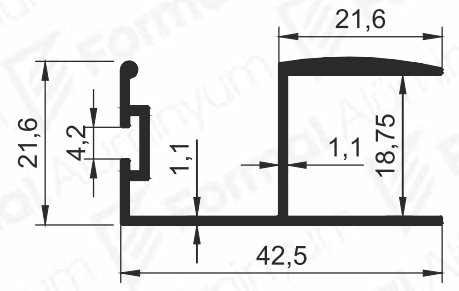

Pr.No: 2242
0,387 kg/m

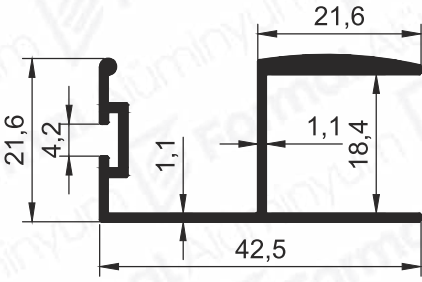

Pr.No: 9745
0,406 kg/m

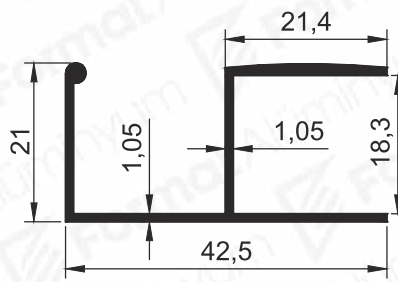

Pr.No: 9322
0,318 kg/m

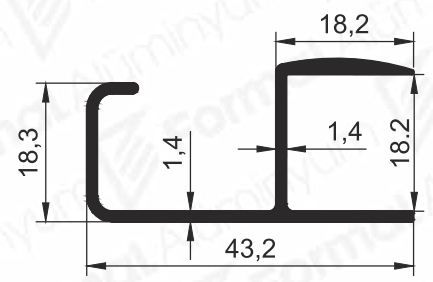

Pr.No: 8775
0,386 kg/m

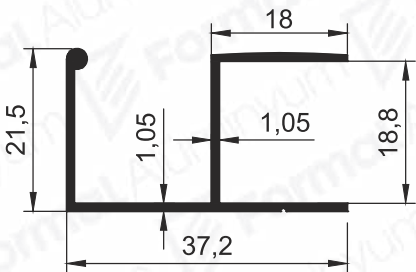

Pr.No: 3714
0,274 kg/m

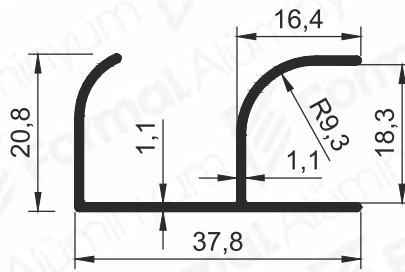

Pr.No: 8737
0,267 kg/m

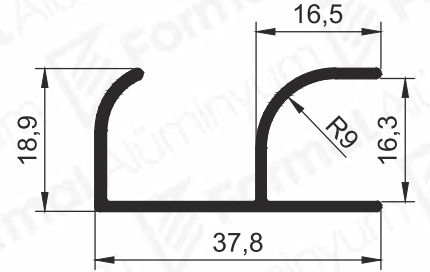

Pr.No: 8753
0,311 kg/m

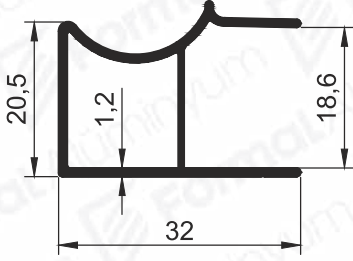

Pr.No: 3945
0,295 kg/m

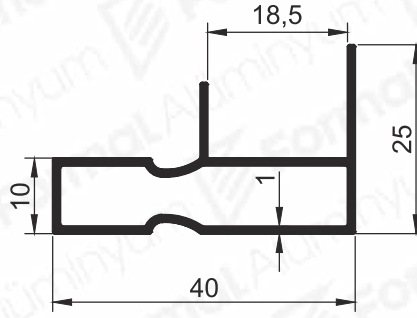

Pr.No: 9964
0,333 kg/m

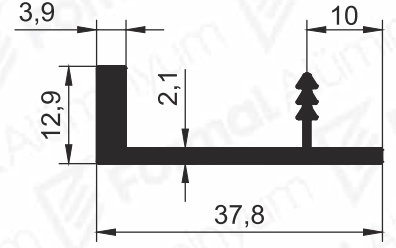

Pr.No: 3555
0,370 kg/m

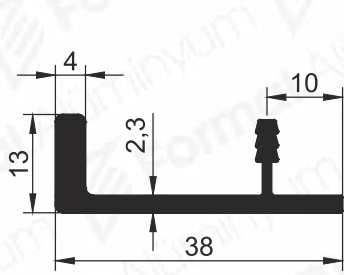

Pr.No: 2786
0,406 kg/m

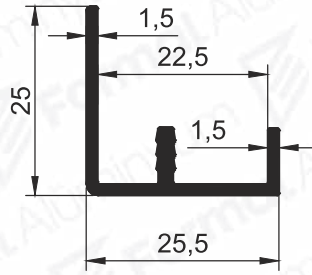

Pr.No: 1497
0,273 kg/m

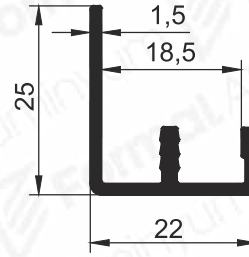

Pr.No: 9187
0,264 kg/m

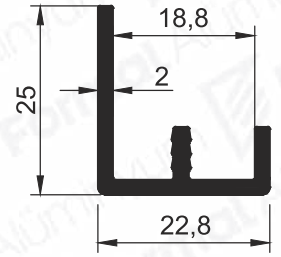

Pr.No: 2214
0,327 kg/m

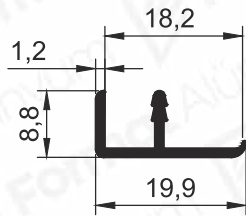

Pr.No: 9149
0,117 kg/m

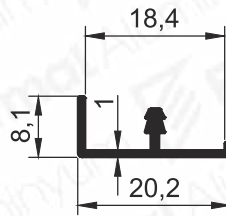

Pr.No: 9719
0,102 kg/m

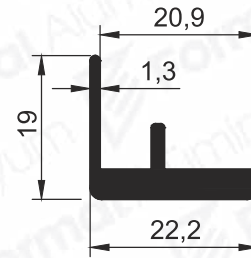

Pr.No: 8755
0,317 kg/m

U Profil

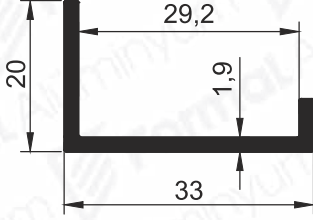

Pr.No: 1767
0,289 kg/m

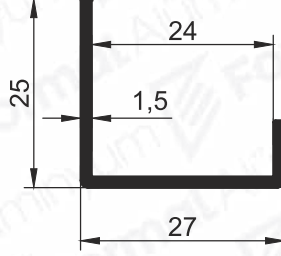

Pr.No: 1578
0,234 kg/m

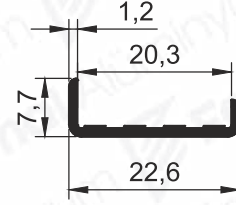

Pr.No: 9991
0,108 kg/m

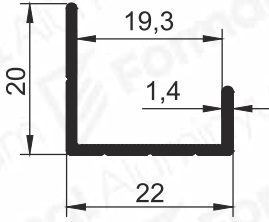

Pr.No: 1615
0,167 kg/m

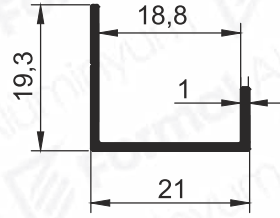

Pr.No: 1629
0,130 kg/m

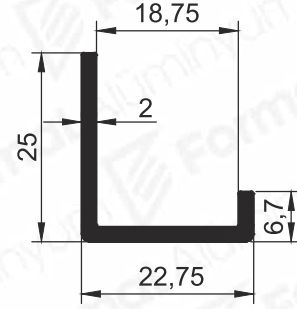

Pr.No: 2428
0,272 kg/m

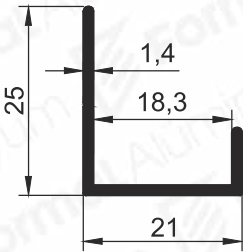

Pr.No: 9871
0,190 kg/m

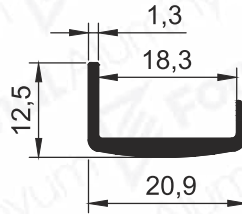

Pr.No: 8738
0,168 kg/m

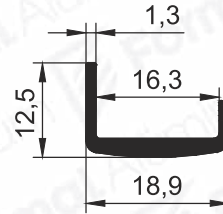

Pr.No: 8743
0,160 kg/m

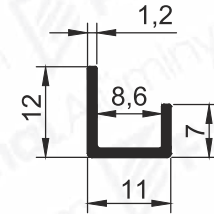

Pr.No: 9706
0,089 kg/m

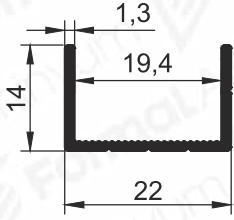

Pr.No: 1656
0,159 kg/m

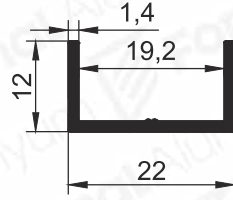

Pr.No: 1438
0,164 kg/m

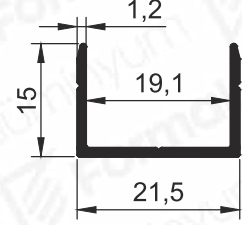

Pr.No: 1601
0,155 kg/m

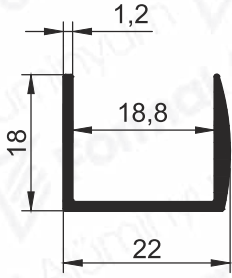

Pr.No: 2232
0,201 kg/m

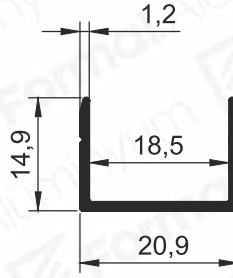

Pr.No: 8846
0,154 kg/m

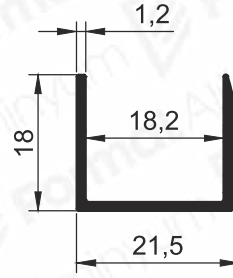

Pr.No: 8574
0,199 kg/m

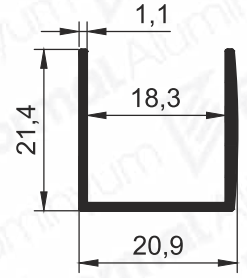

Pr.No: 1257
0,192 kg/m

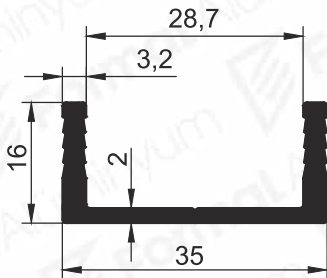

Pr.No: 8774
0,409 kg/m

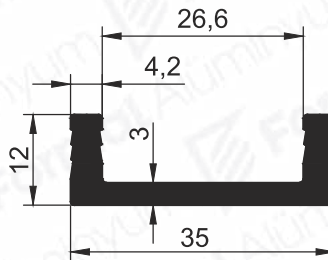

Pr.No: 9434
0,476 kg/m

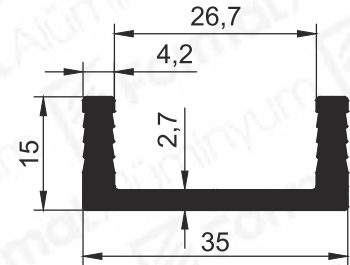

Pr.No: 8728
0,513 kg/m

H Profil

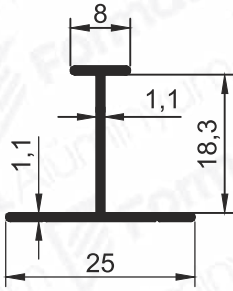

Pr.No: 9870
0,151 kg/m

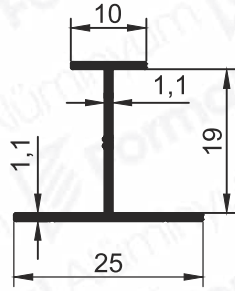

Pr.No: 1439
0,158 kg/m

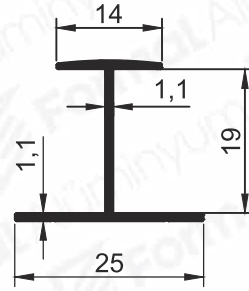

Pr.No: 4751
0,171 kg/m

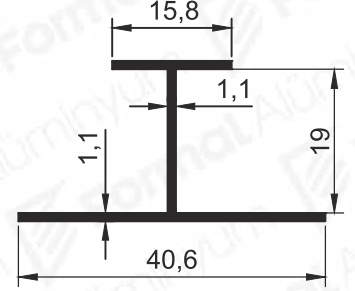

Pr.No: 8159
0,225 kg/m

Aski borusu

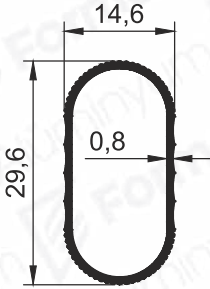

Pr.No: 1916
0,174 kg/m

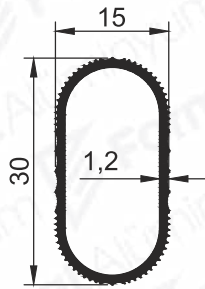

Pr.No: 8847
0,195 kg/m

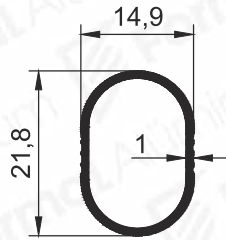

Pr.No: 9746
0,143 kg/m

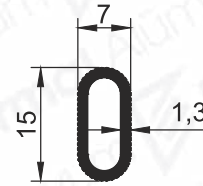

Pr.No: 9749
0,112 kg/m

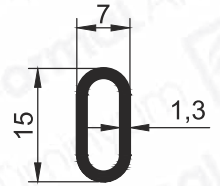

Pr.No: 9393
0,119 kg/m

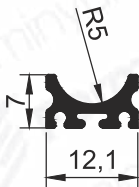

Pr.No: 1075
0,108 kg/m

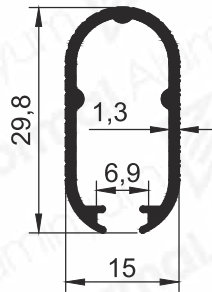

Pr.No: 1074
0,260 kg/m



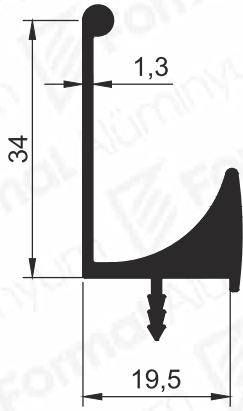

Pr.No: 9684
0,482 kg/m

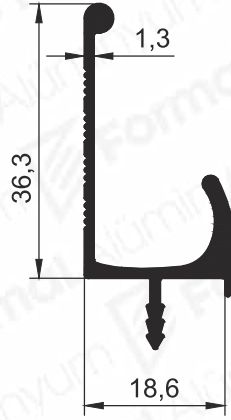

Pr.No: 4252
0,357 kg/m

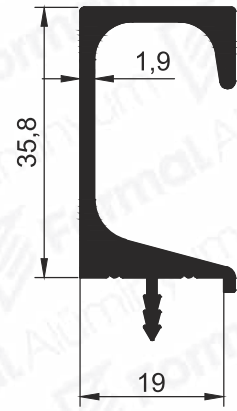

Pr.No: 3556
0,593 kg/m

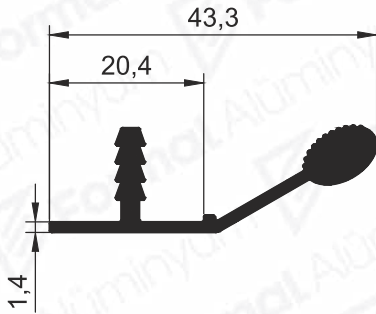

Pr.No: 2805
0,390 kg/m

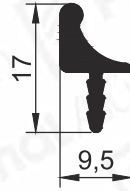

Pr.No: 1444
0,144 kg/m

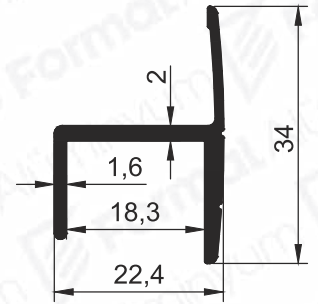

Pr.No: 1246
0,319 kg/m

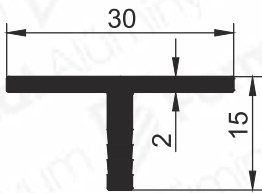

Pr.No: 8730
0,273 kg/m

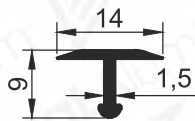

Pr.No: 1852
0,074 kg/m

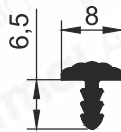

Pr.No: 9190
0,077 kg/m



Pr.No: 1323
0,061 kg/m

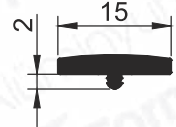

Pr.No: 9286
0,105 kg/m

Sürme serisi

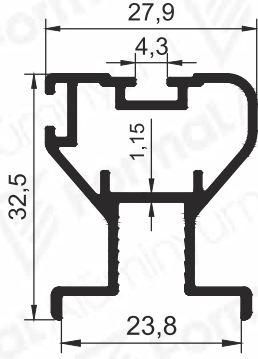

Pr.No: 1750
0,432 kg/m

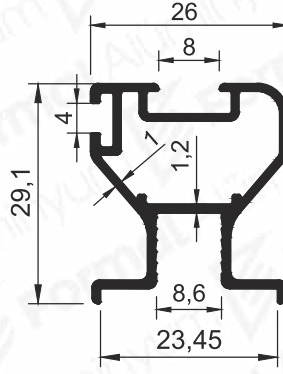

Pr.No: 9632
0,378 kg/m

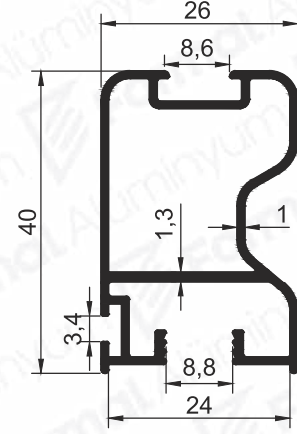

Pr.No: 1806
0,467 kg/m

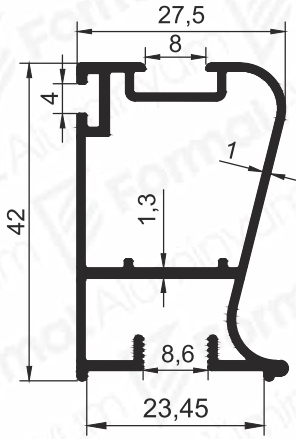

Pr.No: 1727
0,506 kg/m

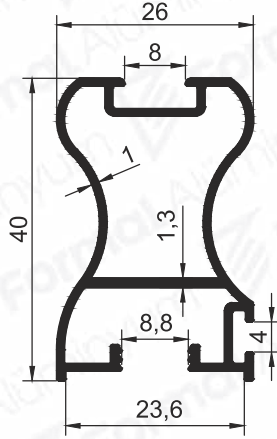

Pr.No: 2233
0,452 kg/m

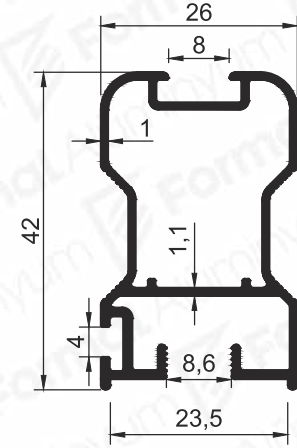

Pr.No: 9633
0,481 kg/m

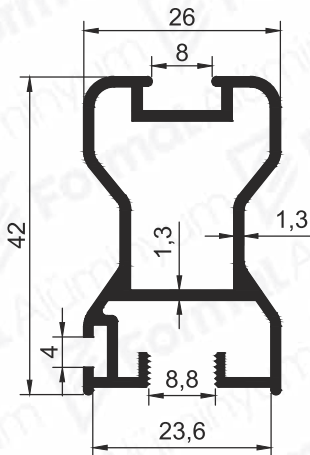

Pr.No: 8540
0,585 kg/m

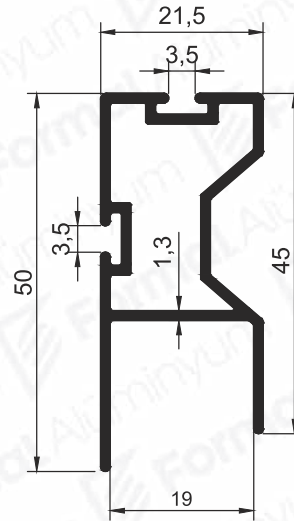

Pr.No: 9291
0,526 kg/m

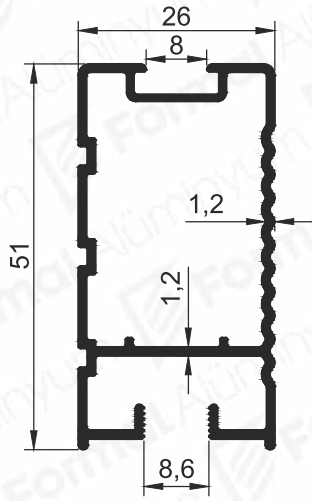

Pr.No: 9634
0,574 kg/m

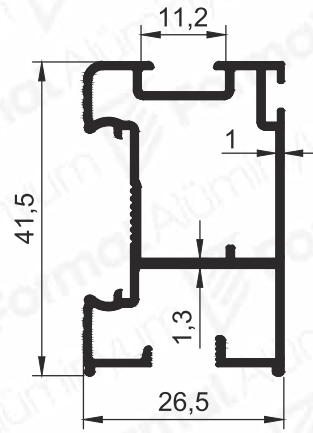

Pr.No: 3501
0,497 kg/m

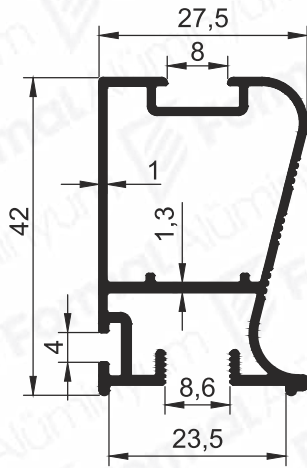

Pr.No: 9718
0,498 kg/m

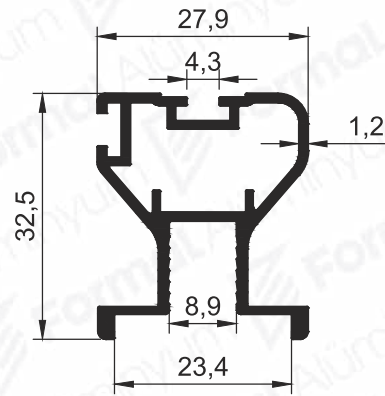

Pr.No: 8995
0,487 kg/m

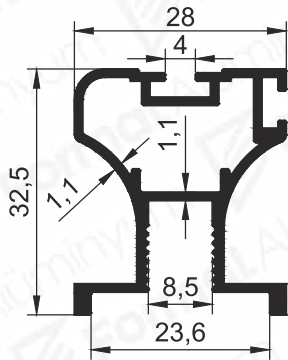

Pr.No: 1469
0,475 kg/m

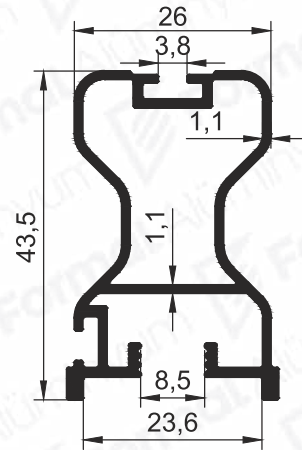

Pr.No: 1468
0,560 kg/m

Orta kayıt sürme profili

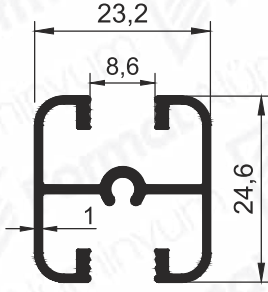

Pr.No: 1465
0,333 kg/m

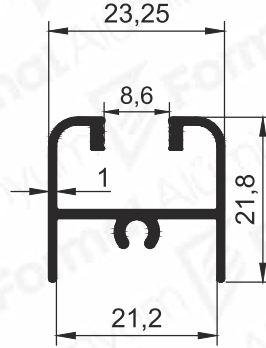

Pr.No: 1466
0,269 kg/m

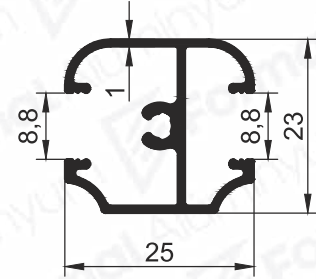

Pr.No: 4412
0,307 kg/m

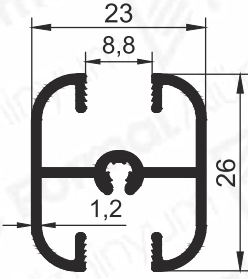

Pr.No: 8536
0,357 kg/m

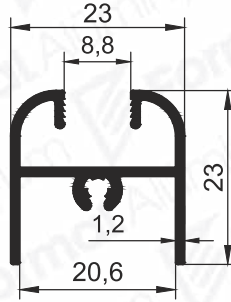

Pr.No: 8537
0,302 kg/m

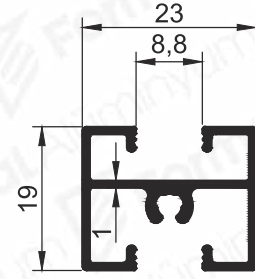

Pr.No: 3509
0,294 kg/m

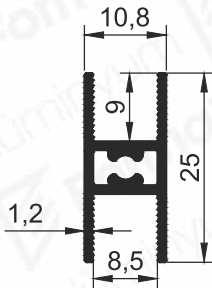

Pr.No: 1739
0,230 kg/m

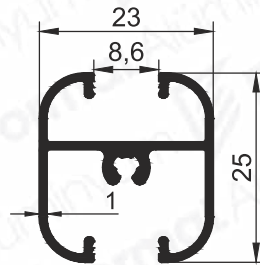

Pr.No: 9621
0,307 kg/m

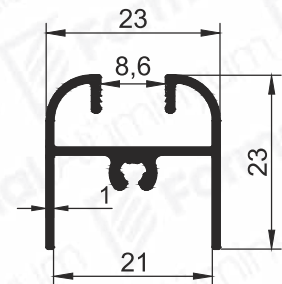

Pr.No: 9622
0,269 kg/m

Alt kayıt teker sürme profili

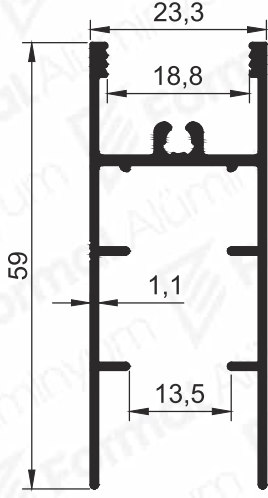

Pr.No: 4360
0,520 kg/m

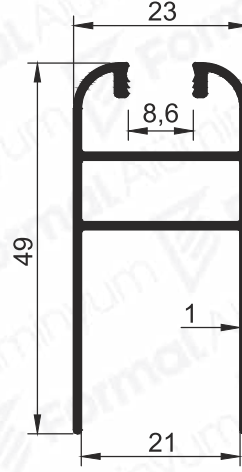

Pr.No: 9623
0,430 kg/m

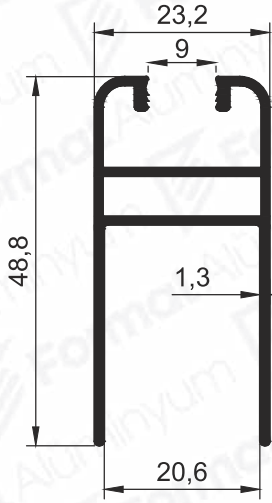

Pr.No: 8541
0,514 kg/m

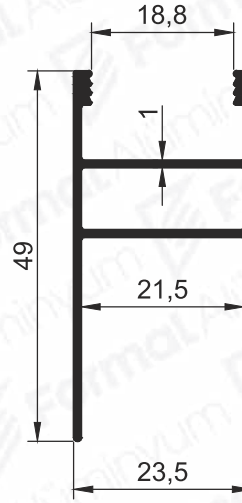

Pr.No: 2708
0,411 kg/m

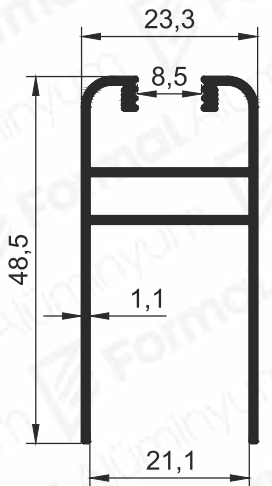

Pr.No: 1467
0,476 Kg/m

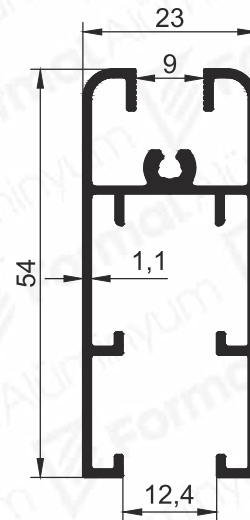

Pr.No: 1427
0,582 kg/m

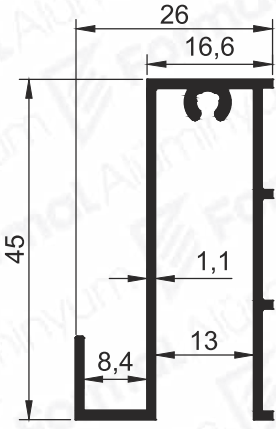

Pr.No: 3990
0,424 kg/m

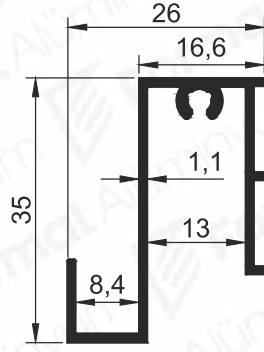

Pr.No: 3991
0,333 kg/m

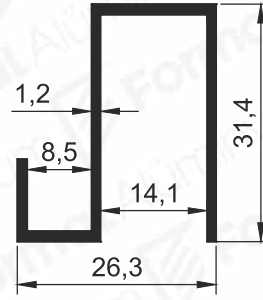

Pr.No: 1645
0,328 kg/m

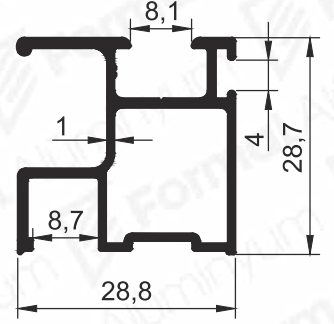

Pr.No: 1641
0,417 kg/m

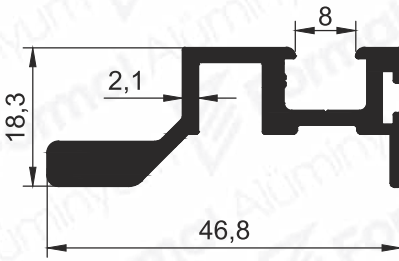

Pr.No: 1642
0,644 kg/m

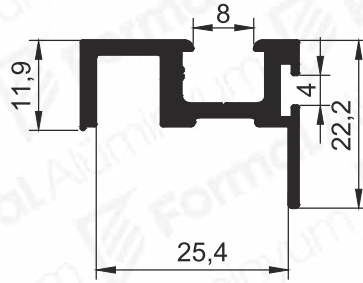

Pr.No: 1643
0,414 kg/m

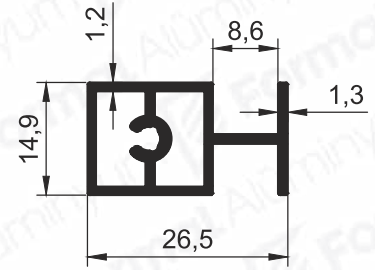

Pr.No: 1644
0,335 kg/m



Pr.No: 5278
0,551 kg/m

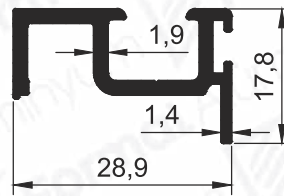

Pr.No: 5277
0,346 kg/m

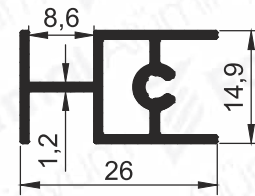

Pr.No: 5279
0,276 kg/m

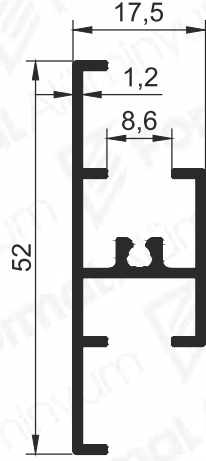

Pr.No: 9736
0,391 kg/m

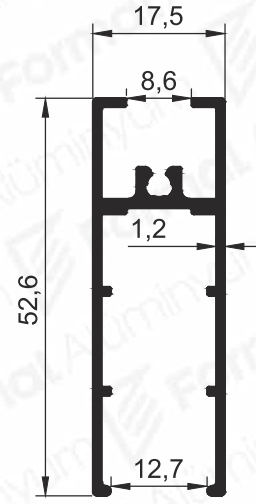

Pr.No: 9735
0,492 kg/m

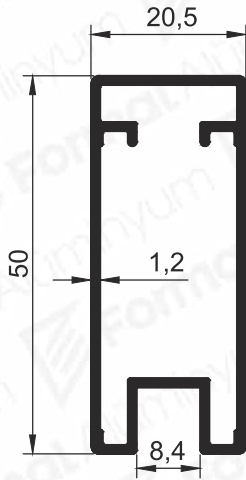

Pr.No: 9965
0,549 kg/m

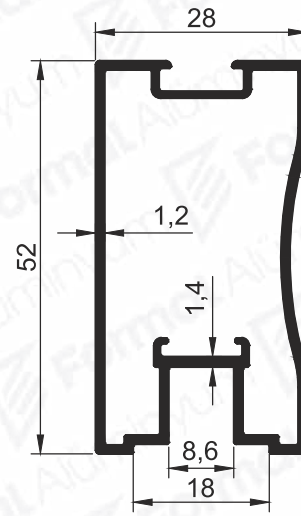

Pr.No: 9734
0,626 kg/m

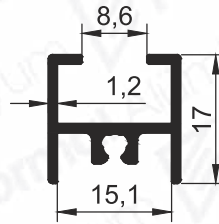

Pr.No: 9737
0,218 kg/m

Ray profilleri

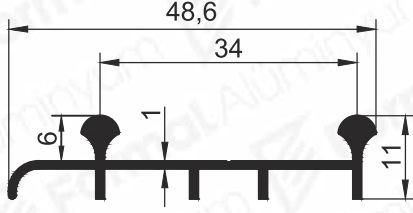

Pr.No: 9625
0,274 kg/m

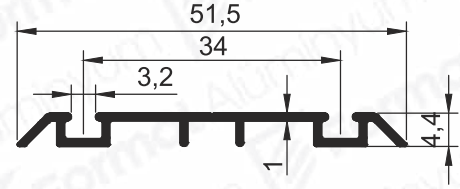

Pr.No: 9626
0,209 kg/m

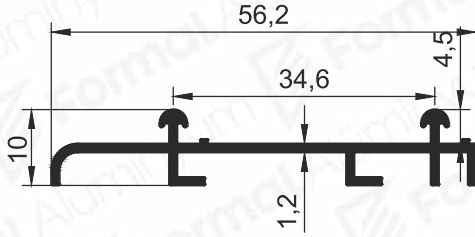

Pr.No: 8994
0,317 kg/m

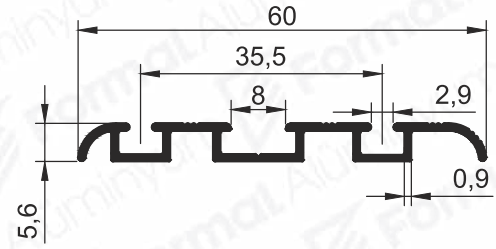

Pr.No: 1590
0,292 kg/m

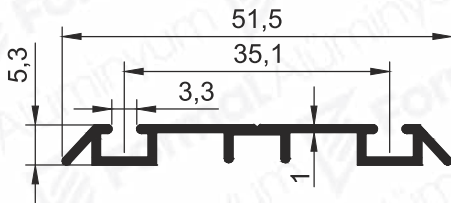

Pr.No:1471
0,243 kg/m

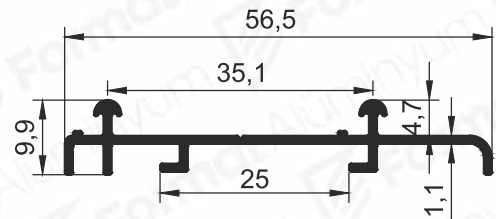

Pr.No:1472
0,290 Kg/m

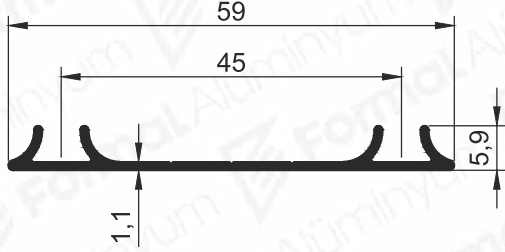

Pr.No: 9838
0,232 kg/m

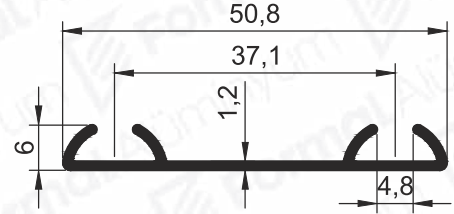

Pr.No: 9869
0,242 kg/m

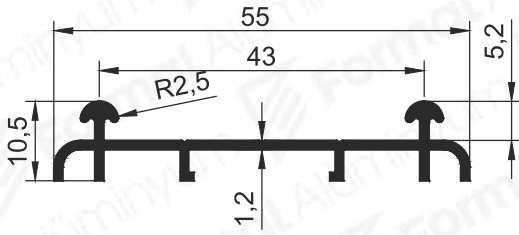

Pr.No: 9687
0,323 kg/m

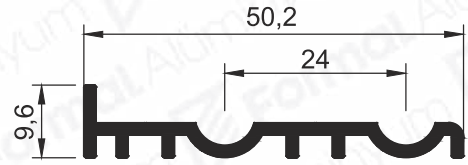

Pr.No: 8886
0,336 kg/m

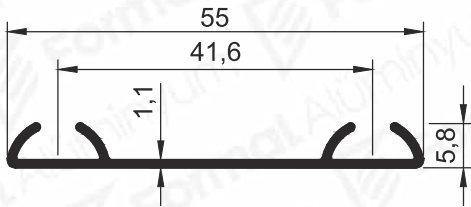

Pr.No: 1741
0,224 kg/m

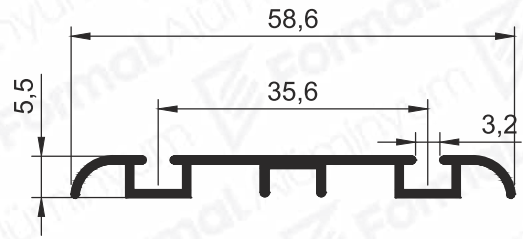

Pr.No: 8534
0,274 kg/m

Sürme E profil

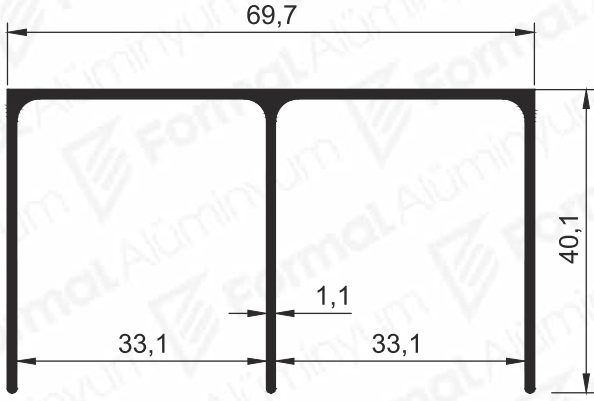

Pr.No: 8535
0,615 kg/m

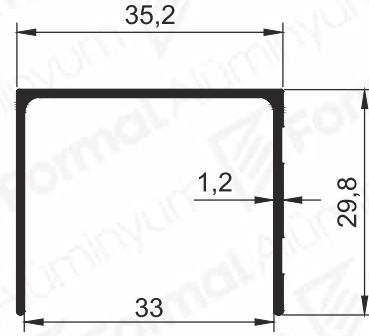

Pr.No: 9720
0,266 kg/m

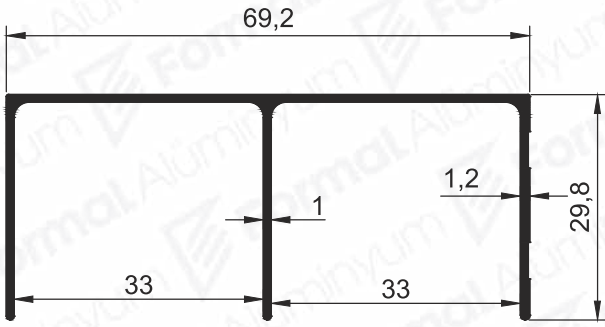

Pr.No: 9624
0,440 kg/m

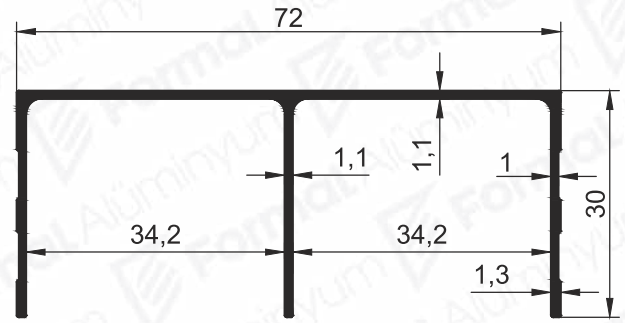

Pr.No:1470
0,493 Kg/m

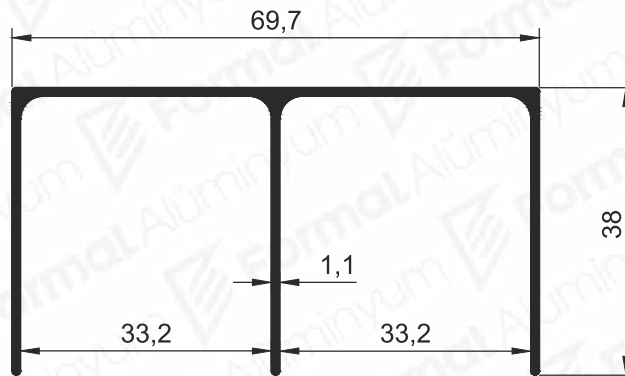

Pr.No: 9355
0,558 kg/m

Tekli ray profilleri

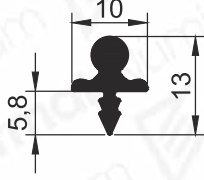

Pr.No: 9556
0,127kg/m

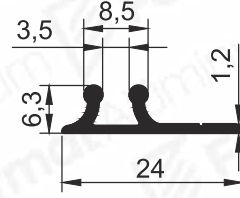

Pr.No: 9968
0,124 kg/m

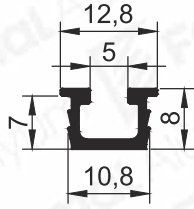

Pr.No: 9688
0,102 kg/m

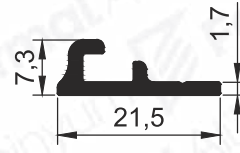

Pr.No: 2205
0,152 kg/m

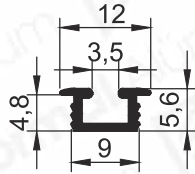

Pr.No: 1134
0,067 kg/m

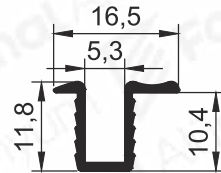

Pr.No: 1186
0,110 kg/m

18 mm Ray profili

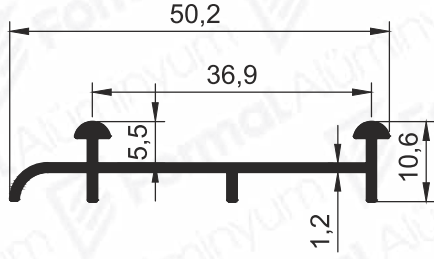
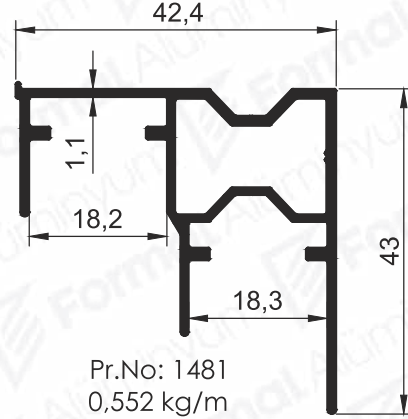
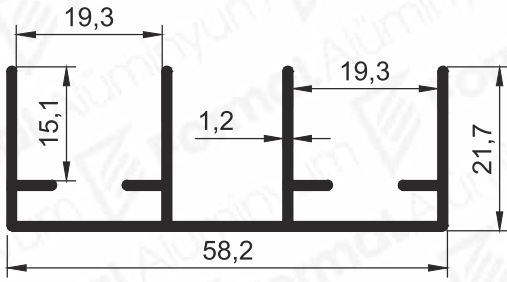
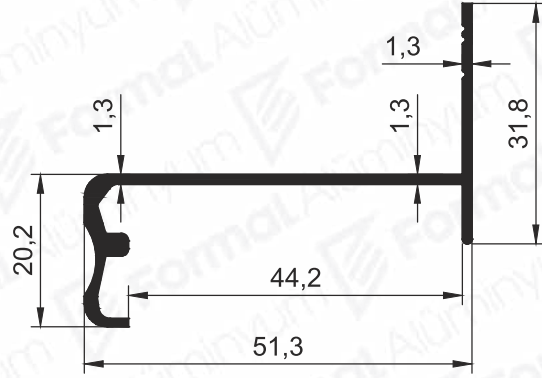
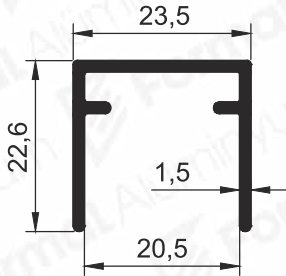
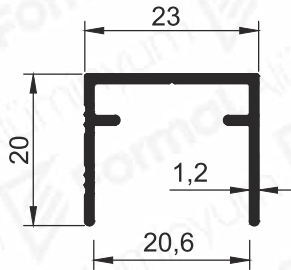
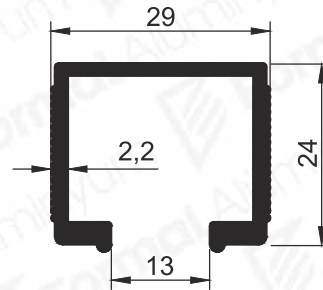
Pr.No: 9287
0,272 kg/mPr.No: 1481
0,552 kg/mPr.No: 9288
0,520 kg/mPr.No: 8109
0,403 kg/mPr.No: 9557
0,292 kg/mPr.No: 9966
0,214 kg/mPr.No: 8589
0,480 kg/m

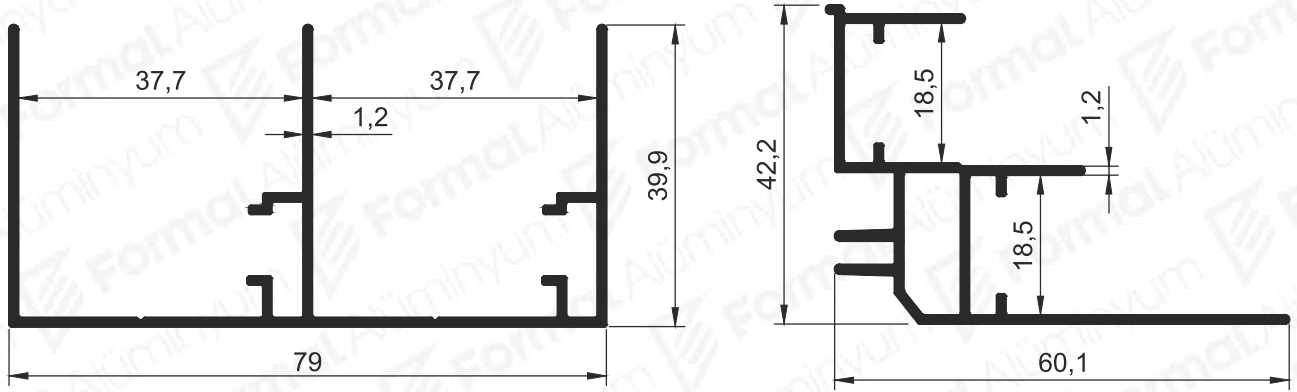

Pr.No: 4611
0,734 kg/m

Pr.No: 2173
0,609 kg/m

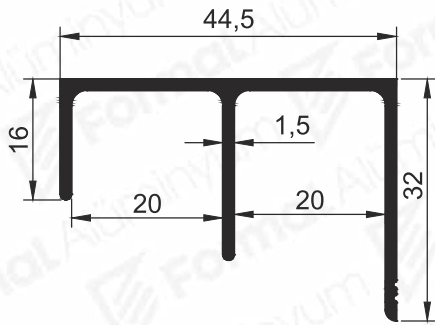

Pr.No: 8108
0,459 kg/m

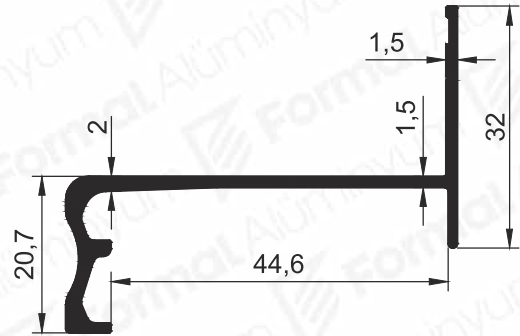

Pr.No:2331
0,473 kg/m

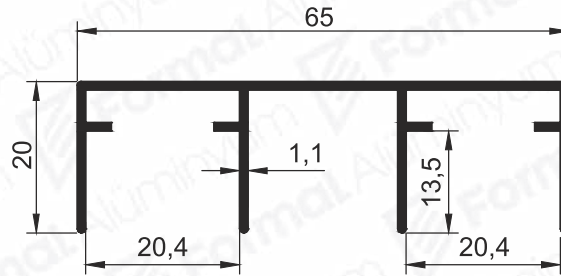

Pr.No: 9686
0,458 kg/m

Çerçeve kapak

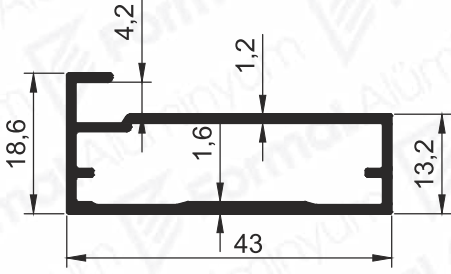

Pr.No: 9832
0,418 kg/m

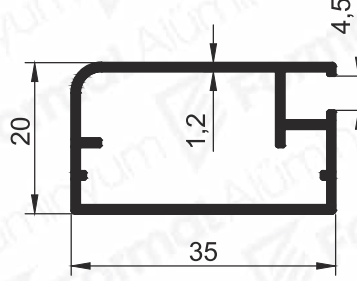

Pr.No: 9993
0,385 kg/m

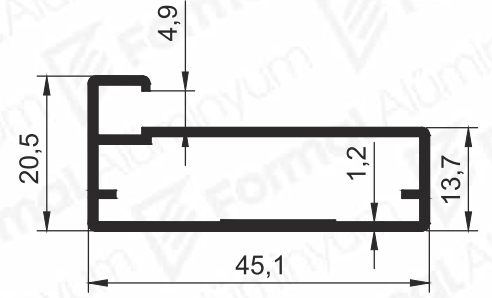

Pr.No: 8868
0,428 kg/m

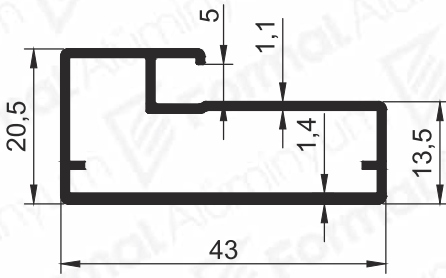

Pr.No: 9630
0,430 kg/m

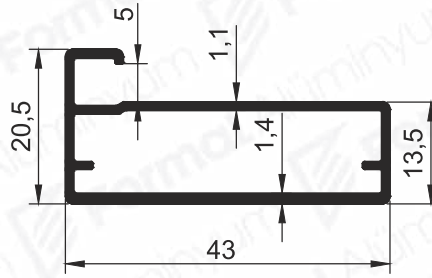

Pr.No: 9631
0,414 kg/m

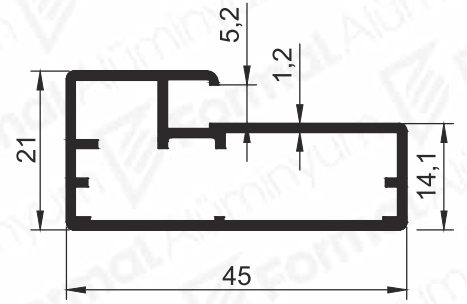

Pr.No: 8884
0,466 kg/m

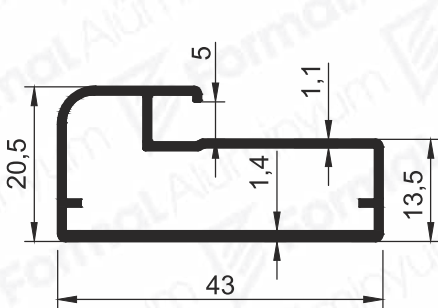

Pr.No: 8867
0,424 kg/m

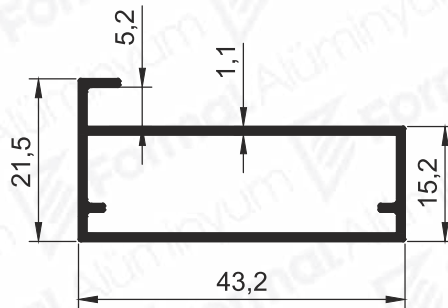

Pr.No: 9889
0,382 kg/m

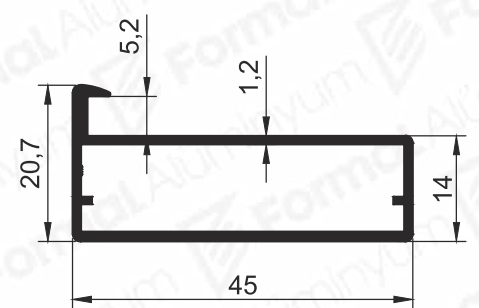

Pr.No: 1851
0,423 kg/m

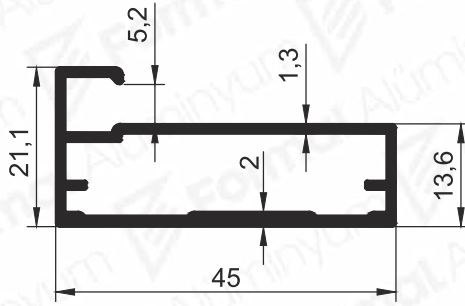

Pr.No: 9868
0,522 kg/m

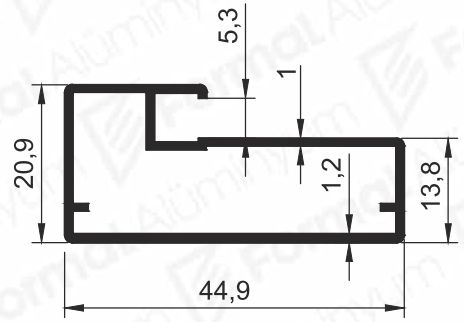

Pr.No: 8866
0,413 kg/m

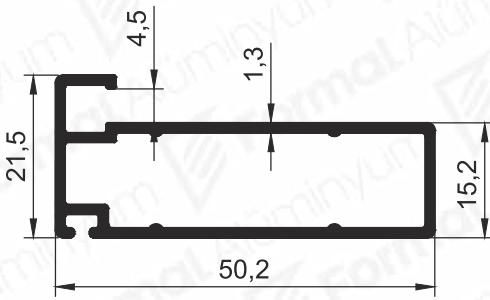

Pr.No: 8745
0,517 kg/m

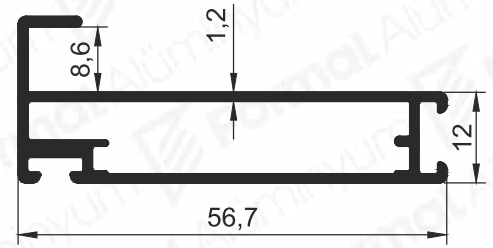

Pr.No: 9967
0,563 kg/m

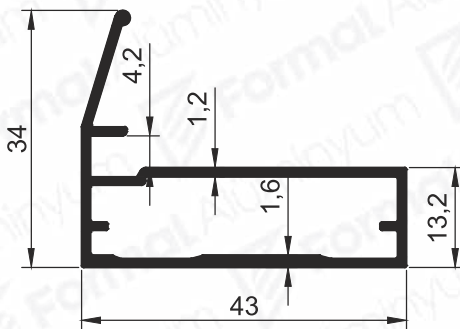

Pr.No: 9833
0,474 kg/m

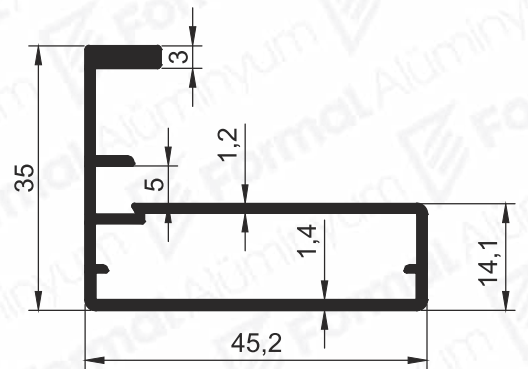

Pr.No: 2795
0,573 kg/m

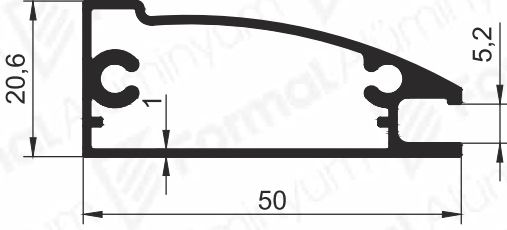

Pr.No: 9285
0,533 kg/m

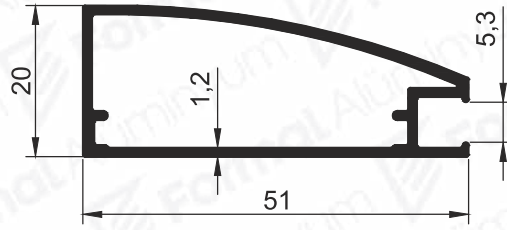

Pr.No: 9962
0,464 kg/m

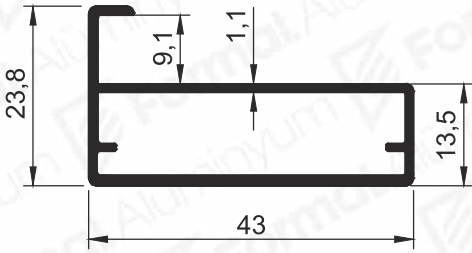

Pr.No: 9990
0,420 kg/m

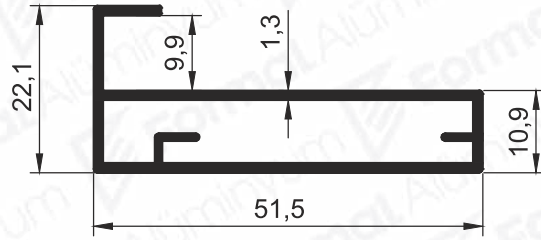

Pr.No: 9867
0,522 kg/m

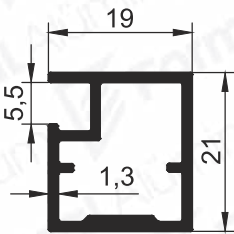

Pr.No: 8729
0,298 kg/m

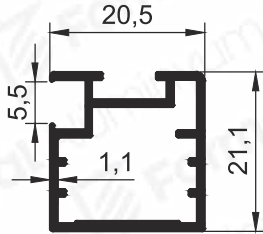

Pr.No: 9822
0,288 kg/m

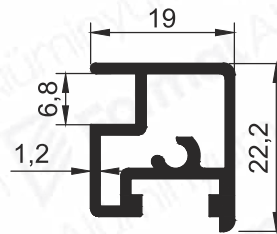

Pr.No: 8754
0,355 kg/m

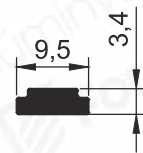

Pr.No: 9823
0,078 kg/m

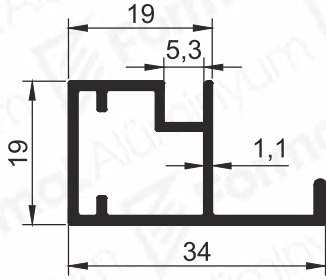

Pr.No: 9834
0,327 kg/m

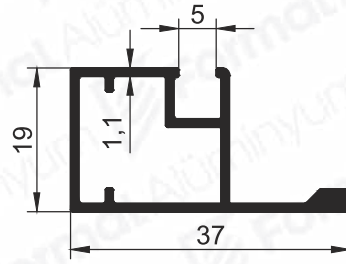

Pr.No: 1810
0,333 kg/m

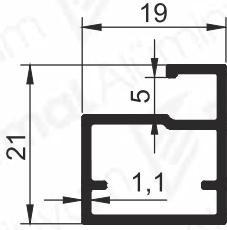

Pr.No: 9629
0,239 kg/m

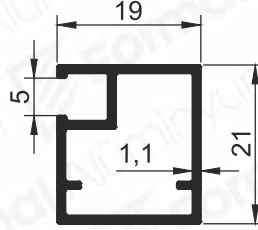

Pr.No: 9627
0,261 kg/m

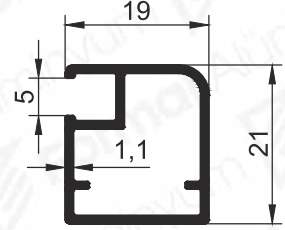

Pr.No: 9628
0,255 kg/m

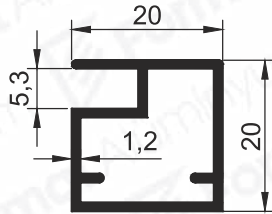

Pr.No: 9865
0,287 kg/m

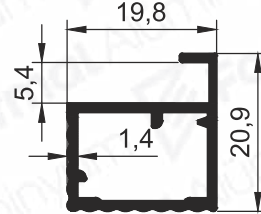

Pr.No: 9866
0,261 kg/m

Pr.No: 9710
0,489 kg/m

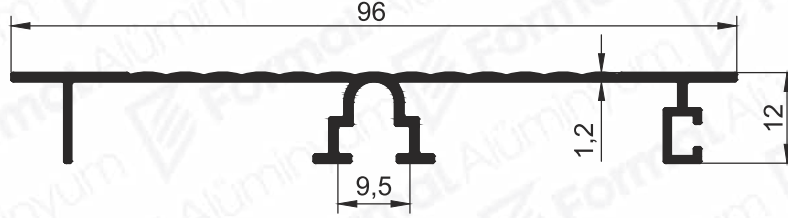

Pr.No: 9972
0,437 kg/m

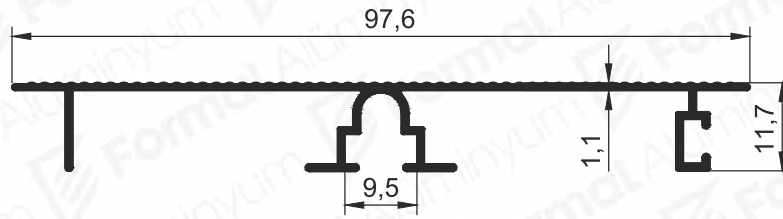

Pr.No: 9740
0,447 kg/m

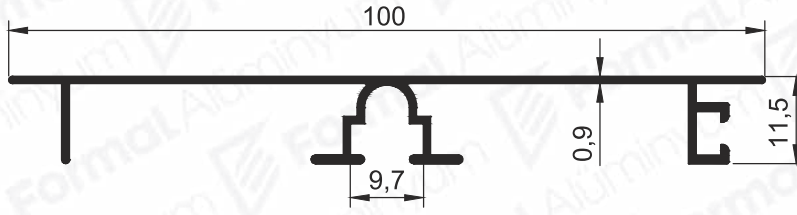

Pr.No: 9741
0,447 kg/m

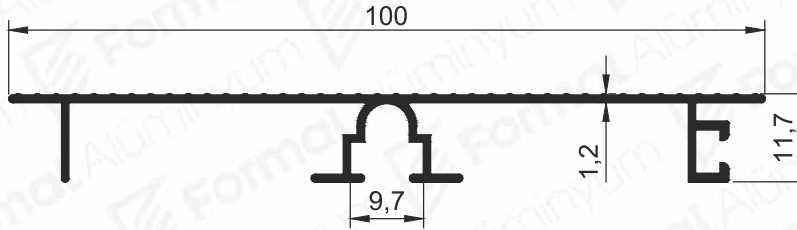

Pr.No: 9711
0,546 kg/m

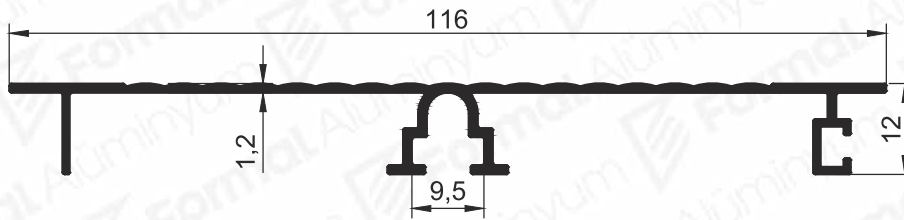

Pr.No: 9973
0,521 kg/m

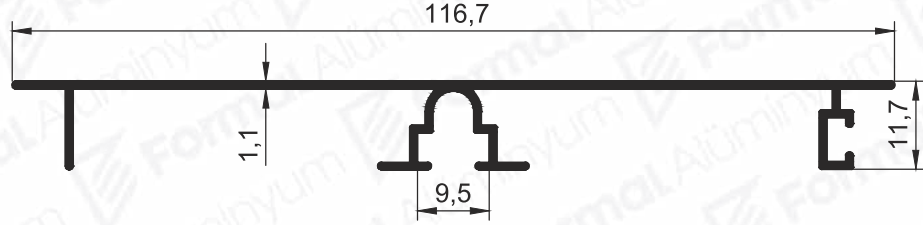

Pr.No: 9974
0,487 kg/m

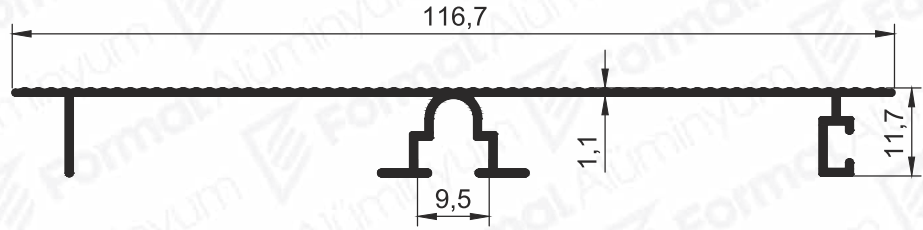

Pr.No: 9738
0,680 kg/m

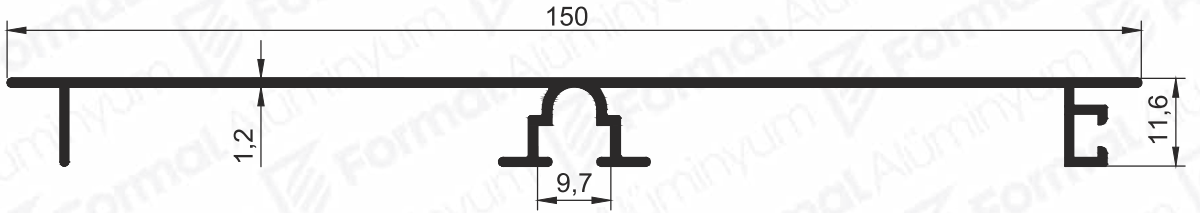

Pr.No: 9739
0,699 kg/m

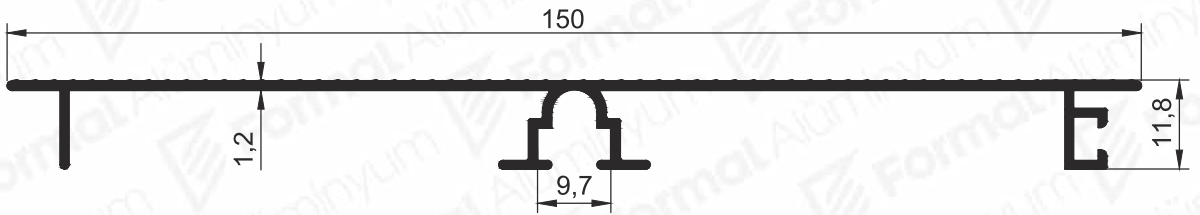

Pr.No: 9975
0,678 kg/m

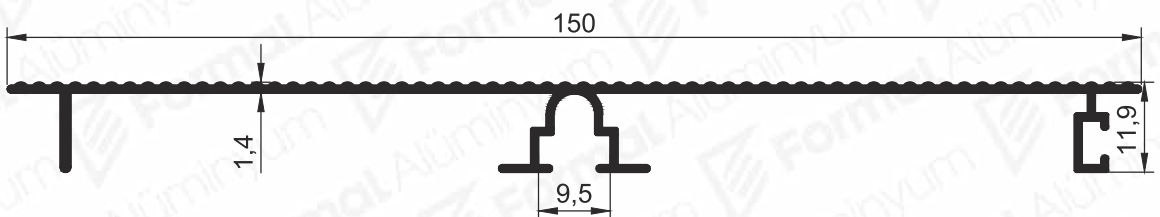

Pr.No: 1925
0,463 kg/m

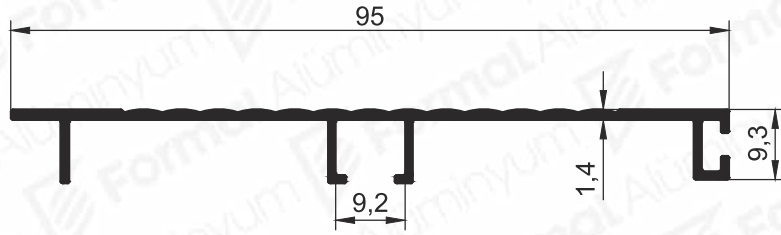

Pr.No: 1751
0,385 kg/m

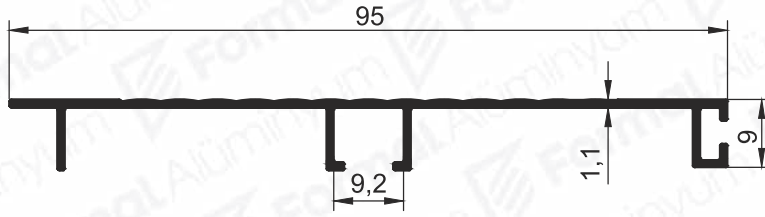

Pr.No: 1752
0,482 kg/m

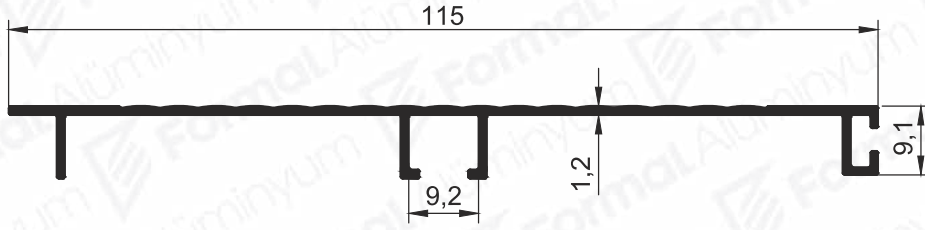

Pr.No: 1926
0,532 kg/m

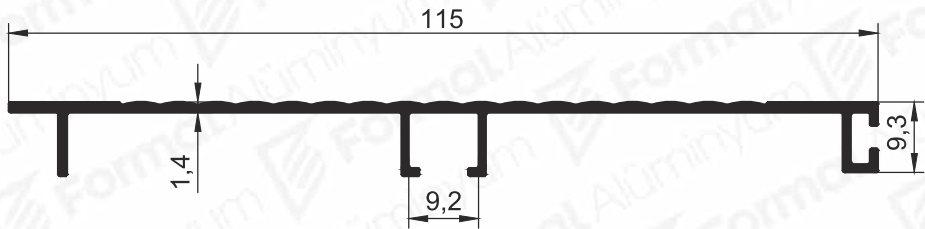

Pr.No: 1753
0,635 kg/m

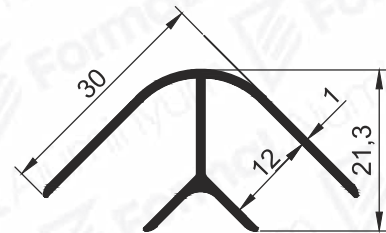
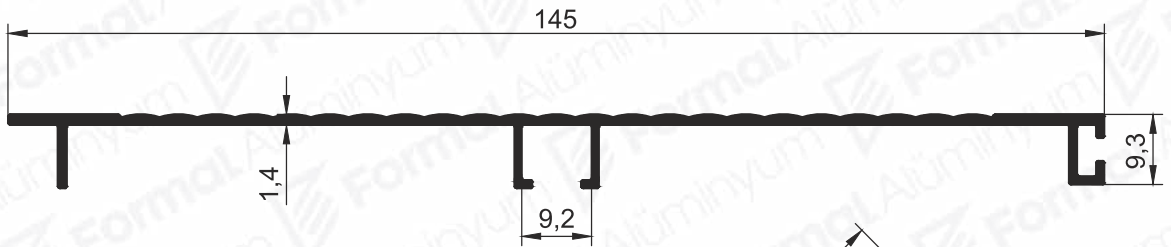

Pr.No: 9744
0,240 kg/m

Ranza

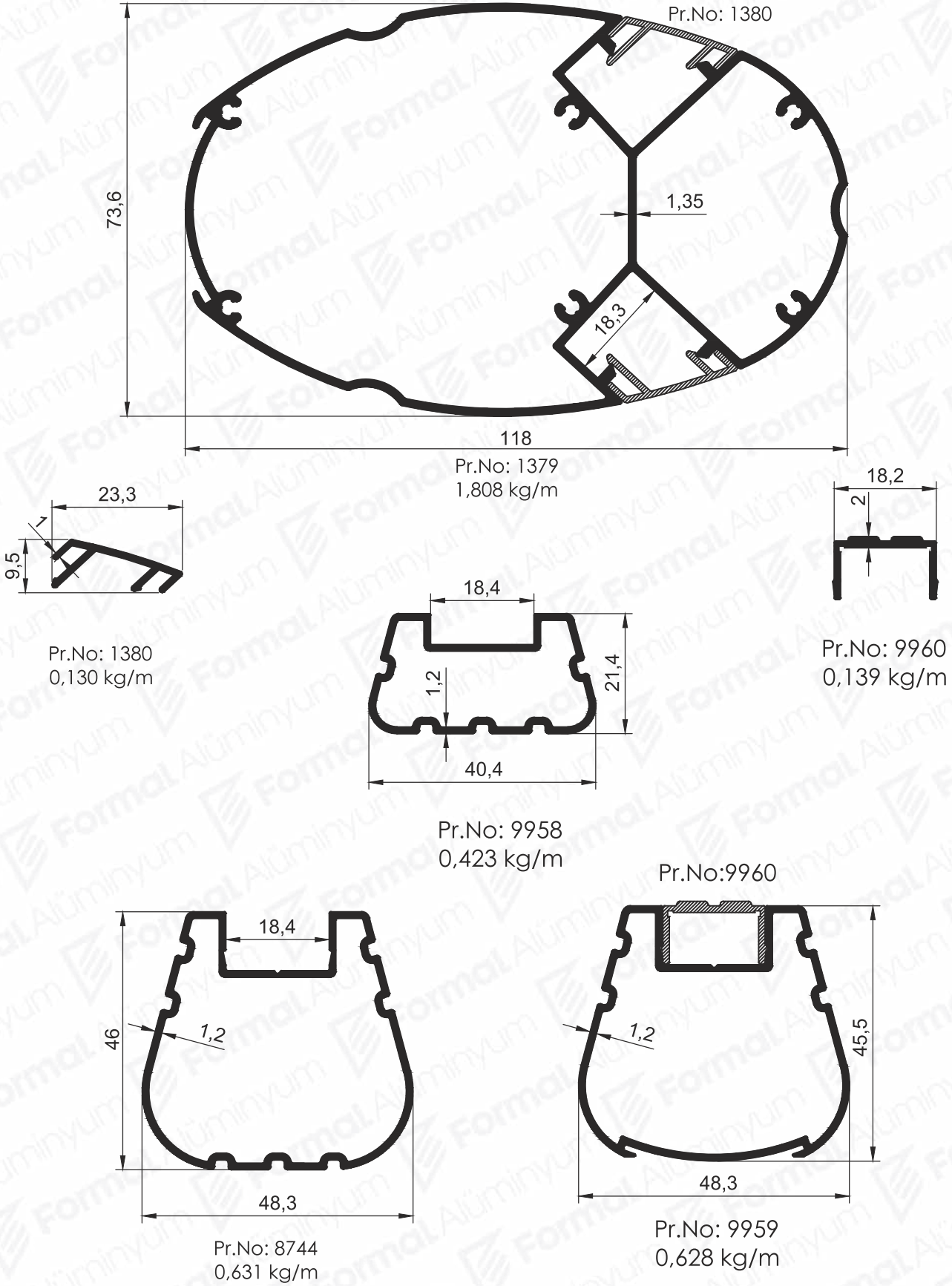

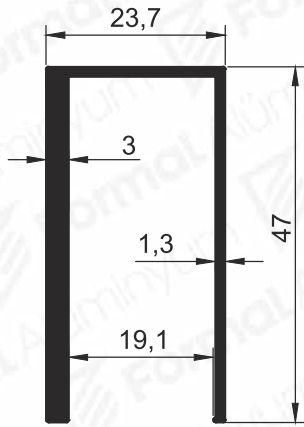

Pr.No:1200
0,616 kg/m

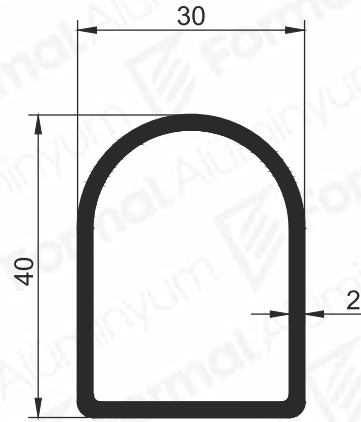

Pr.No: 1140
0,647 kg/m

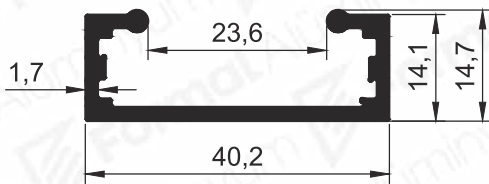

Pr.No: 2556
0,433 kg/m

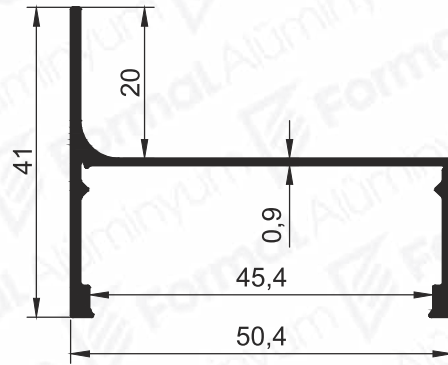

Pr.No: 2557
0,380 kg/m

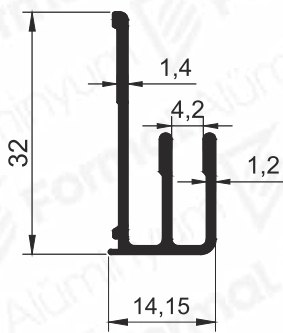

Pr.No: 2330
0,259 kg/m

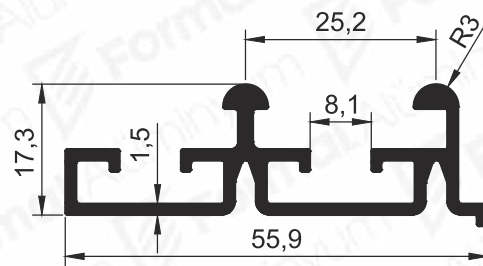

Pr.No: 2172
0,633 kg/m

Tezgaş

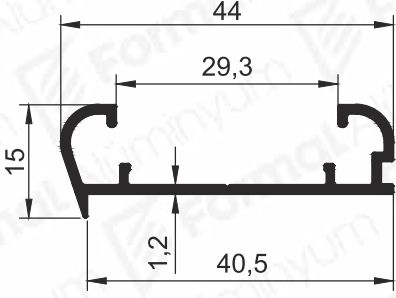

Pr.No: 9956
0,276 kg/m

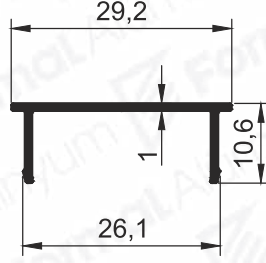

Pr.No: 9957
0,132 kg/m

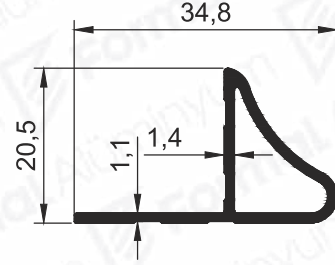

Pr.No: 2518
0,266 kg/m

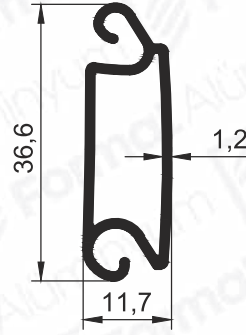
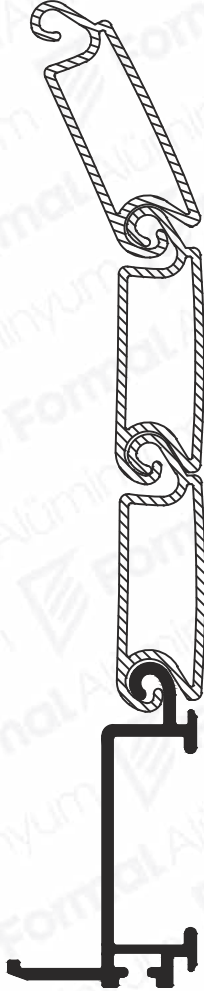

Pr.No: 9681
0,306 kg/m

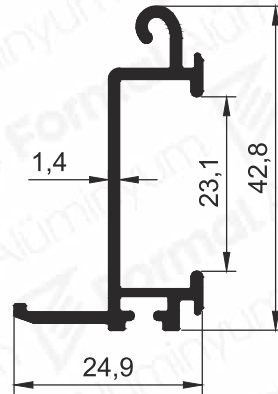

Pr.No: 1123
0,368 kg/m

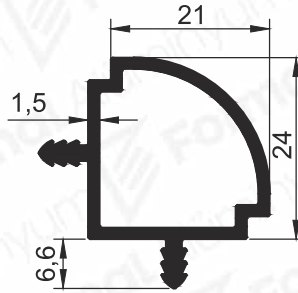

Pr.No: 9360
0,425 kg/m

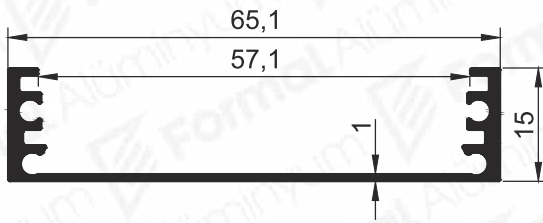

Pr.No: 2548
0,376 kg/m

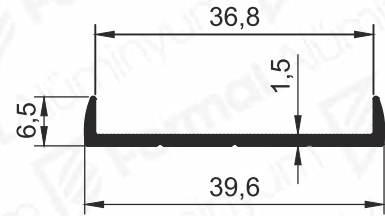

Pr.No: 1614
0,445 kg/m

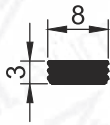

Pr.No: 2122
0,063 kg/m

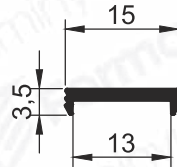

Pr.No: 2123
0,072 kg/m

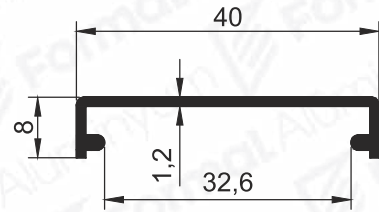

Pr.No: 2124
0,198 kg/m

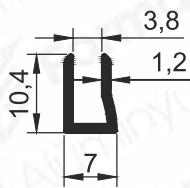

Pr.No: 1141
0,081 kg/m

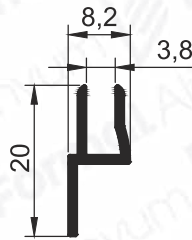

Pr.No: 1142
0,116 kg/m

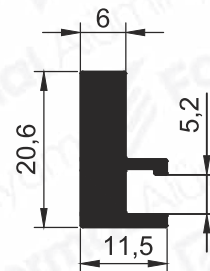

Pr.No: 9284
0,384 kg/m

Parke

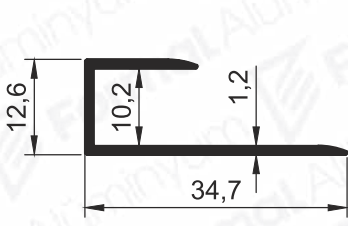

Pr.No: 2241
0,189 kg/m

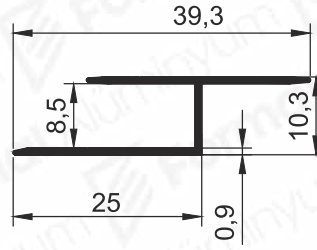

Pr.No: 8968
0,149 kg/m

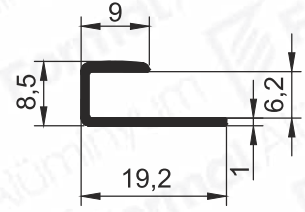

Pr.No: 9348
0,097 kg/m

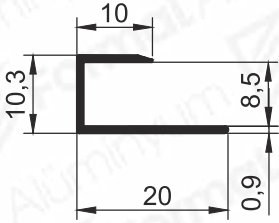

Pr.No: 8967
0,092 kg/m

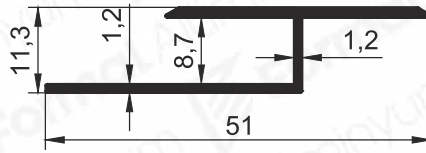

Pr.No: 2196
0,425 kg/m

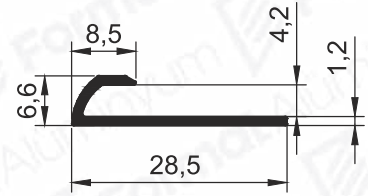

Pr.No: 1028
0,127 kg/m

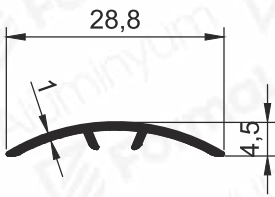

Pr.No: 9747
0,092 kg/m

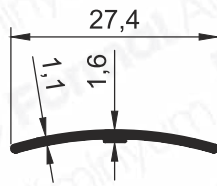

Pr.No: 8969
0,086 kg/m

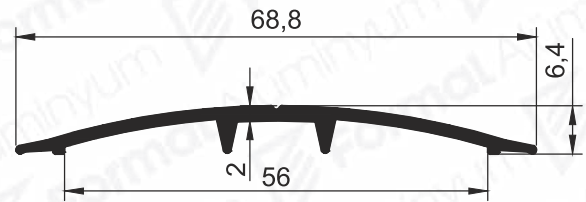

Pr.No: 1968
0,337 kg/m

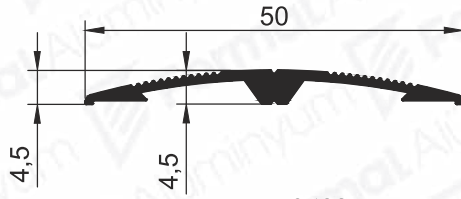

Pr.No: 9428
0,213 kg/m

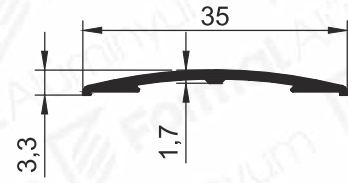

Pr.No: 9443
0,120 kg/m

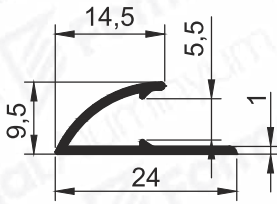

Pr.No: 8760
0,114 kg/m

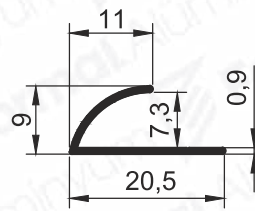

Pr.No: 9748
0,079 kg/m

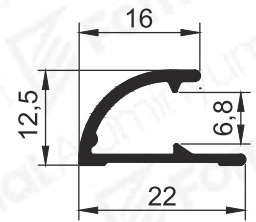

Pr.No: 1813
0,156 kg/m

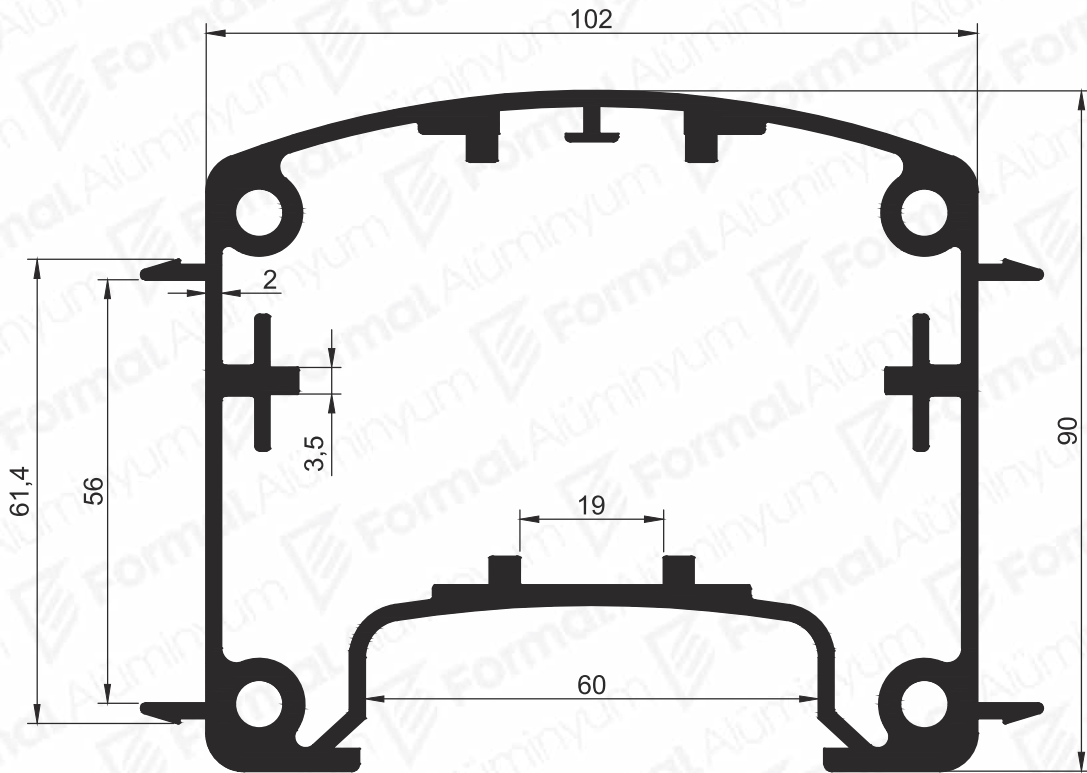

Pr.No: 9530
4,086kg/m

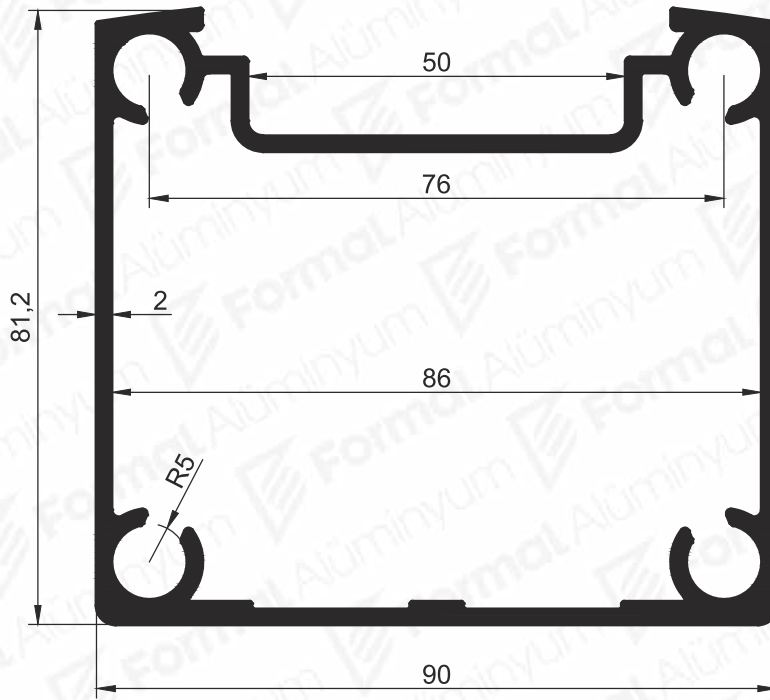

Pr.No: 9295
2,459 kg/m

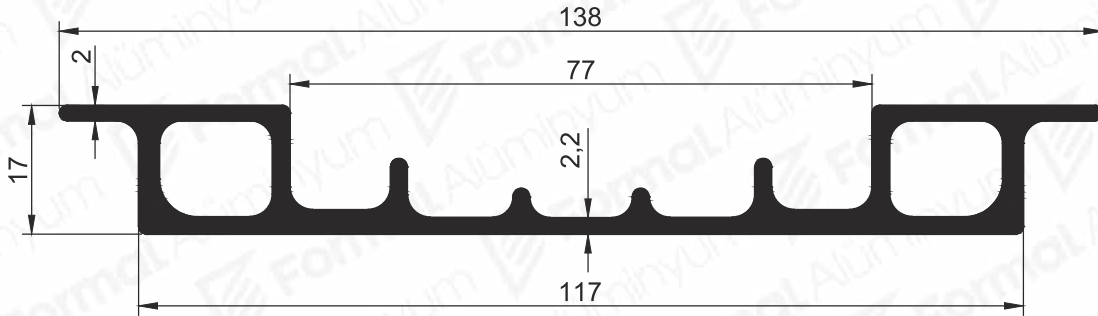

Pr.No: 9294
1,705 kg/m

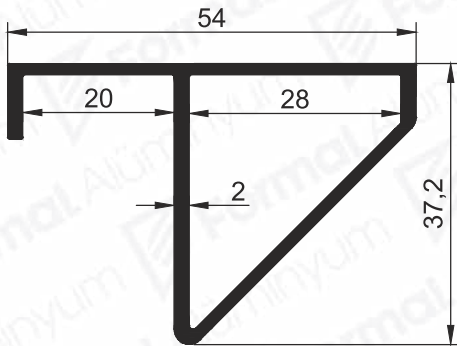

Pr.No: 2715
0,658 kg/m

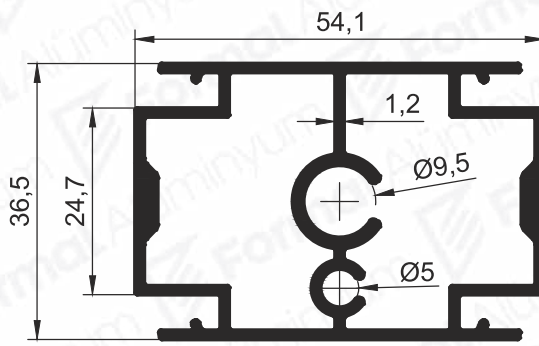

Pr.No: 9296
1,001 kg/m

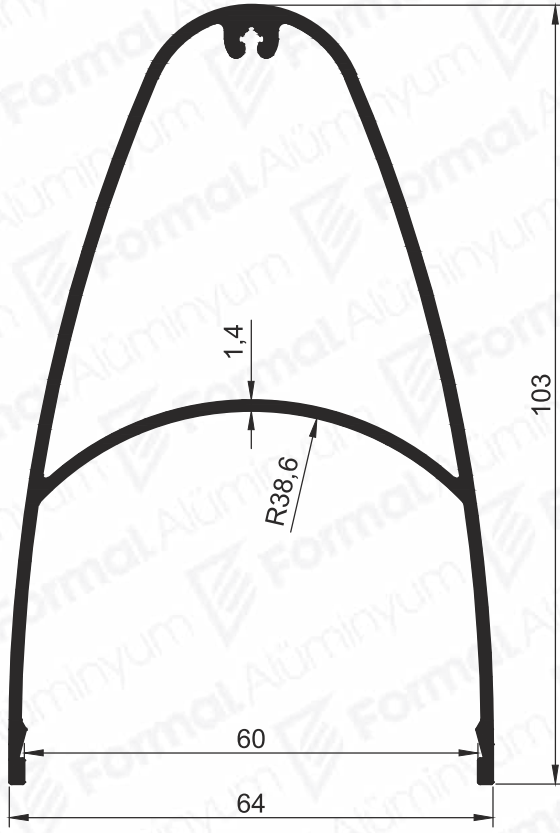

Pr.No: 9531
1,245kg/m

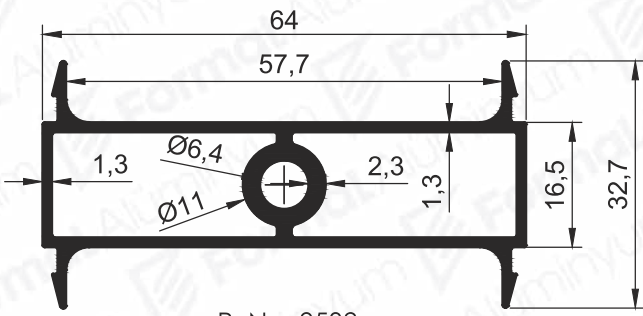
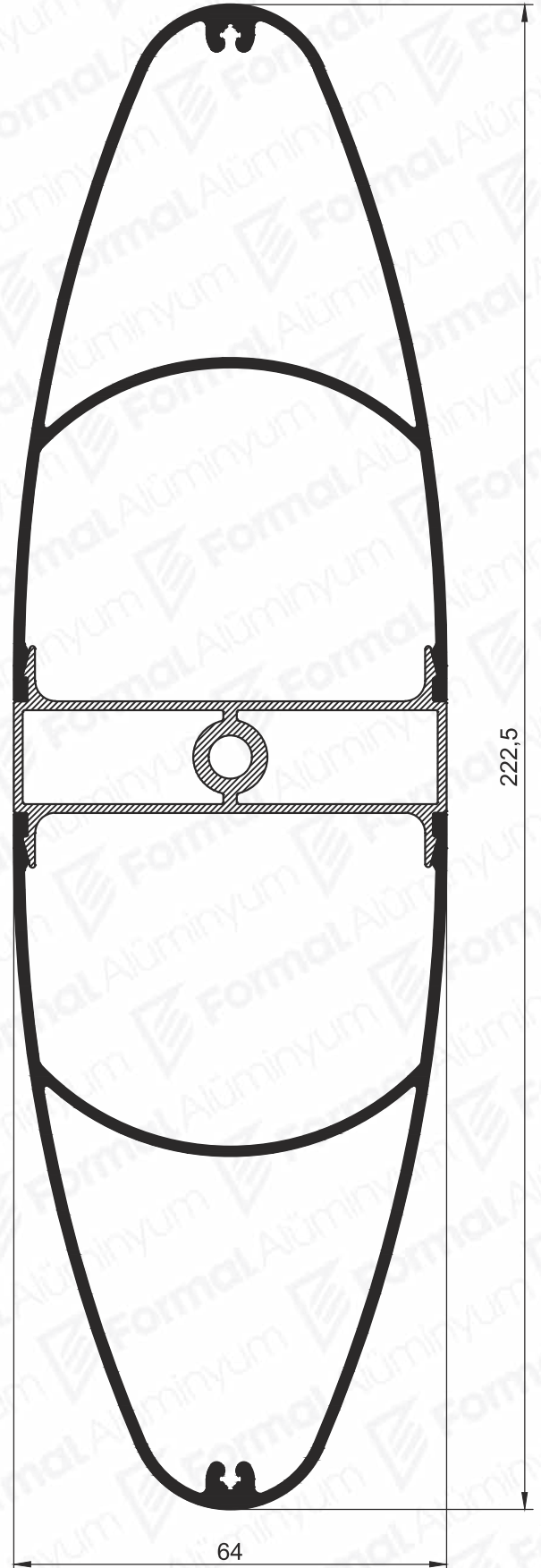

Pr.No: 9532
0,865kg/m

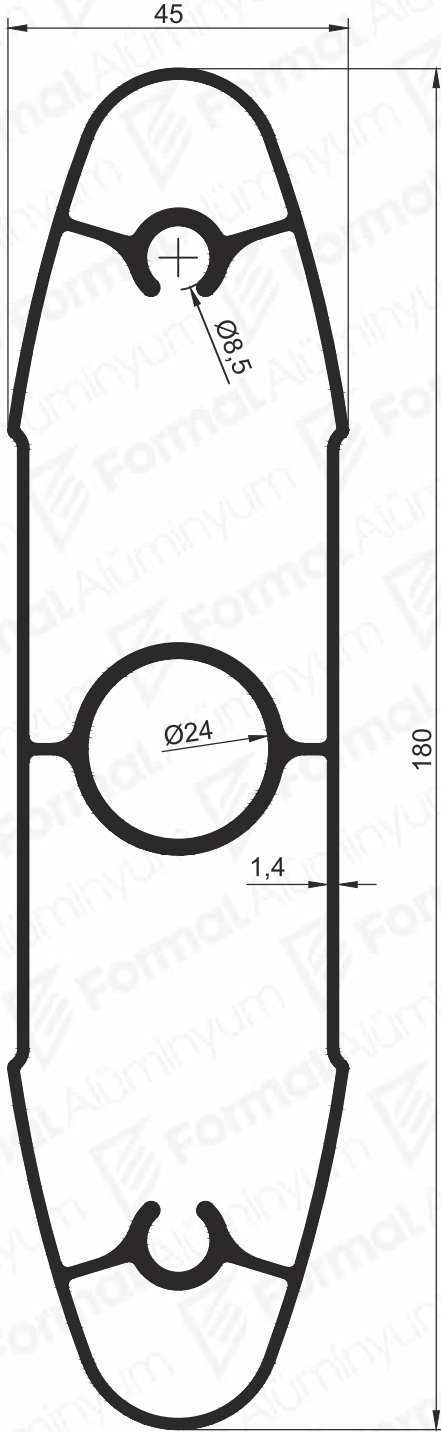

Pr.No: 9826
2,511 kg/m

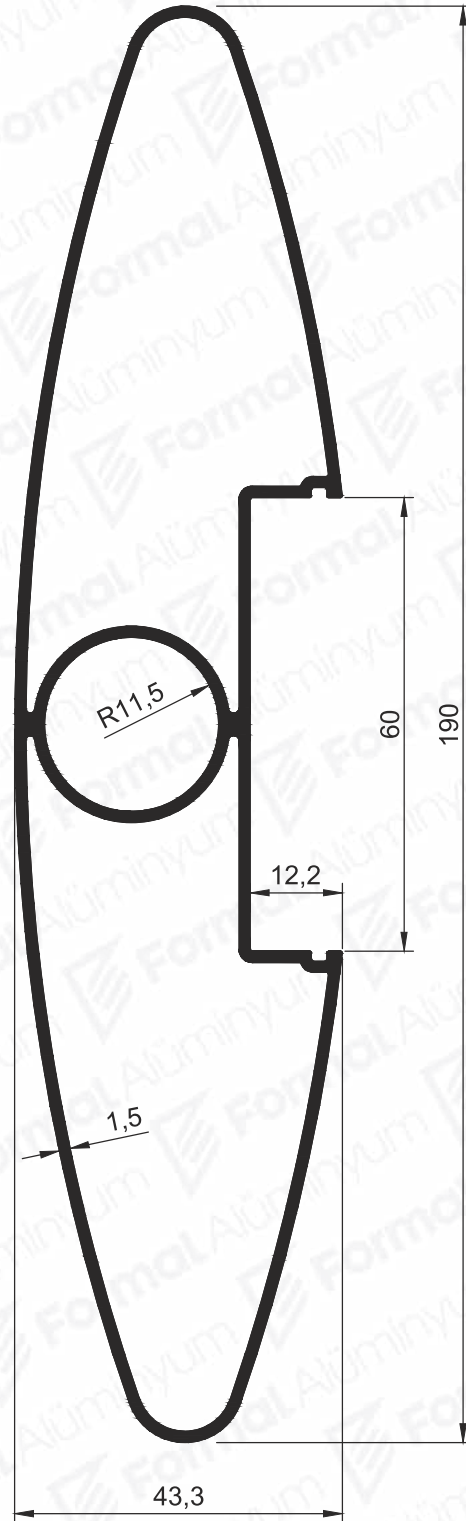

Pr.No: 1765
2,061 kg/m

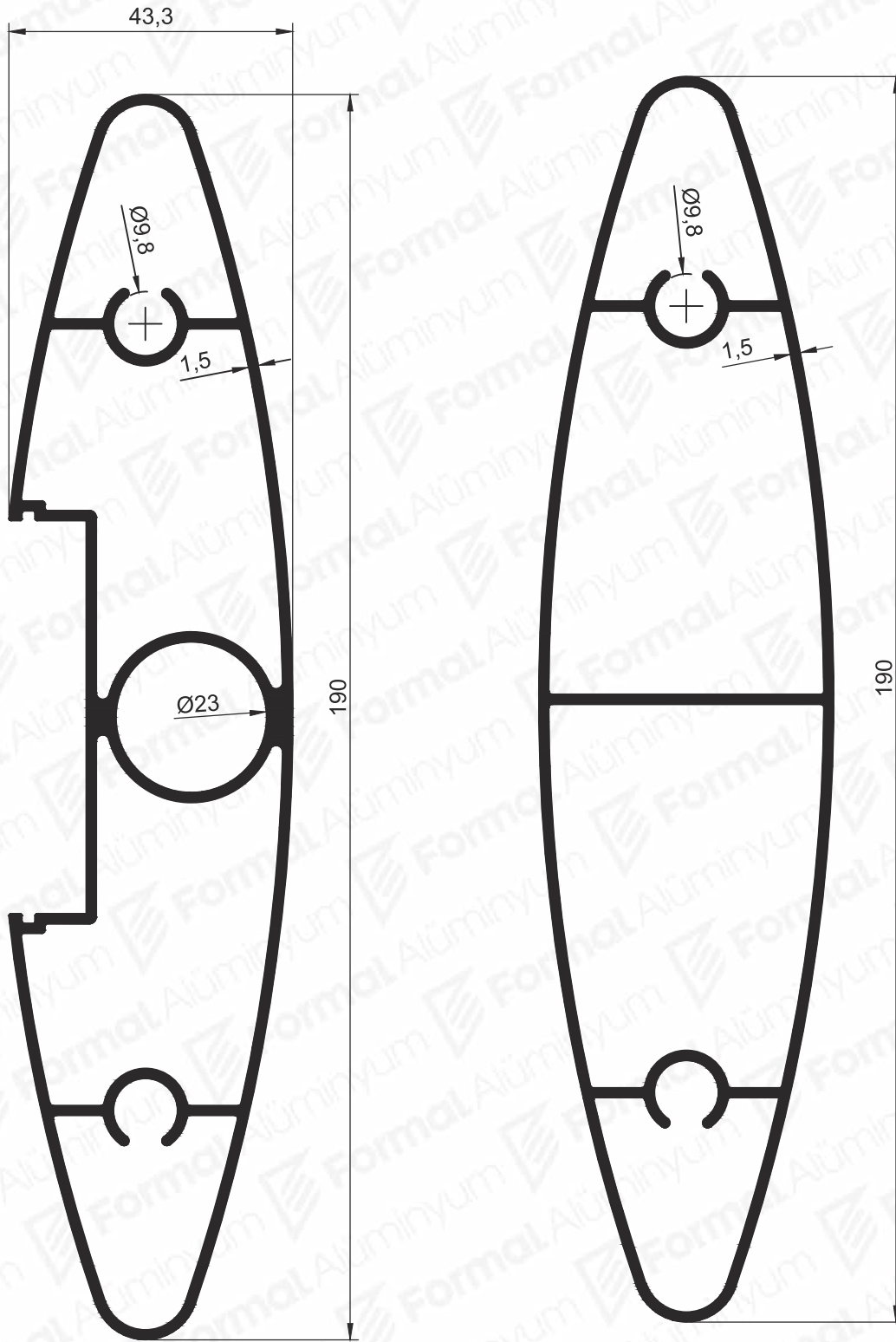

Pr.No: 1037
2,476 kg/m

Pr.No: 1038
2,170 kg/m

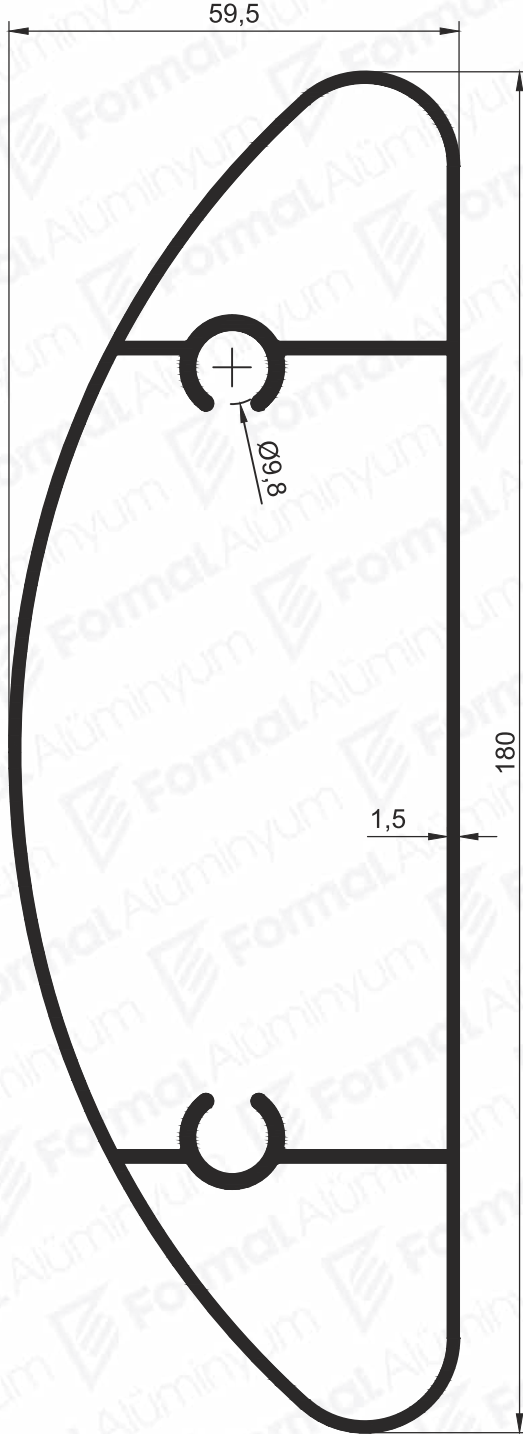

Pr.No: 1117
2,260 kg/m

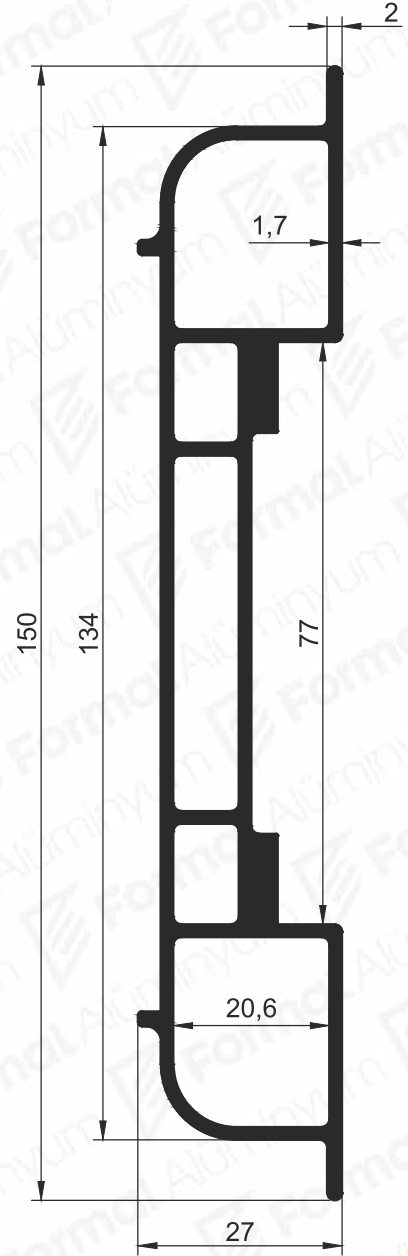

Pr.No: 9533
2,018kg/m

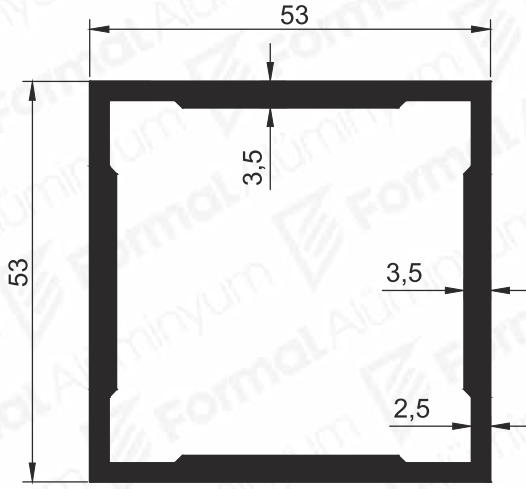

Pr.No: 1401
1,688 kg/m

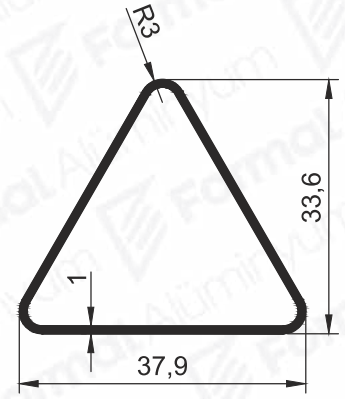

Pr.No: 1787
0,302 kg/m

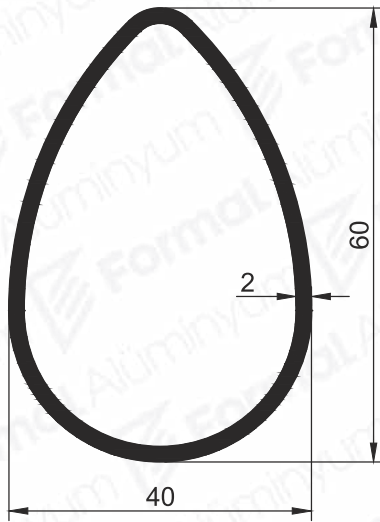

Pr.No: 2716
0,817 kg/m

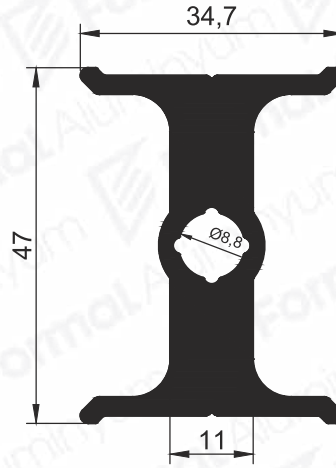

Pr.No: 1402
1,593 kg/m

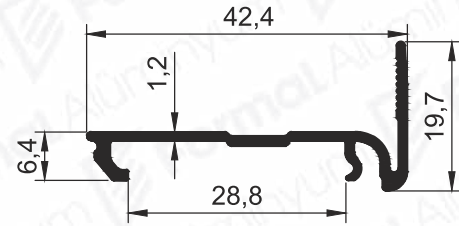

Pr.No: 9976
0,266 kg/m

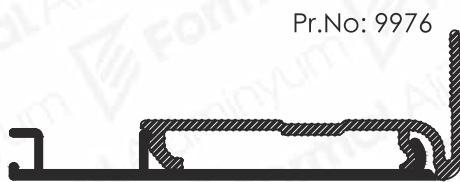

Pr.No: 9977

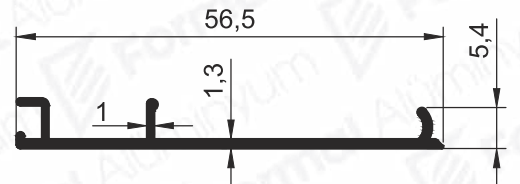

Pr.No: 9977
0,247 kg/m

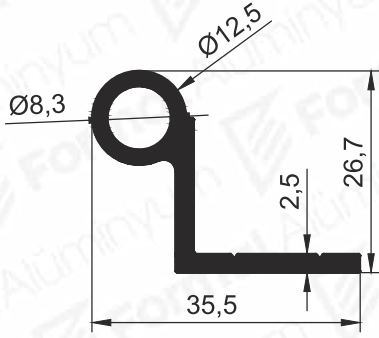

Pr.No: 9595
0,466 kg/m

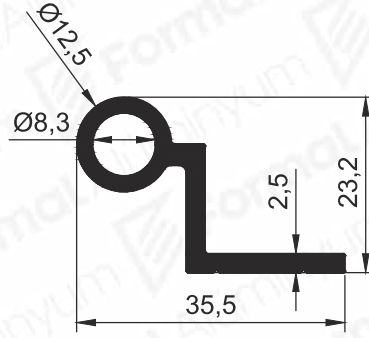

Pr.No: 9596
0,443 kg/m

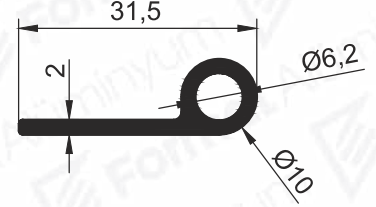

Pr.No: 9592
0,262 kg/m

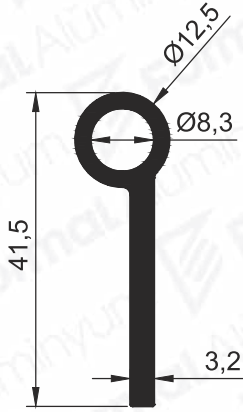

Pr.No: 9643
0,444 kg/m

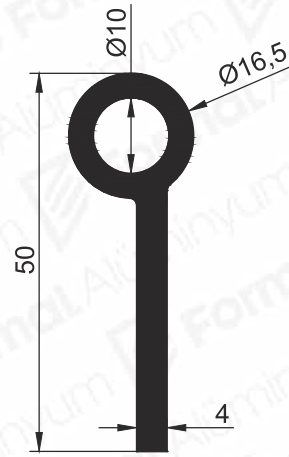

Pr.No: 9635
0,737 kg/m

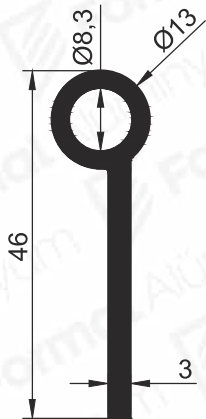

Pr.No: 9636
0,486 kg/m

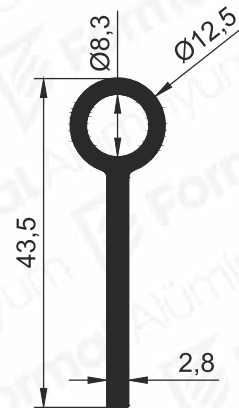

Pr.No: 9637
0,428 kg/m

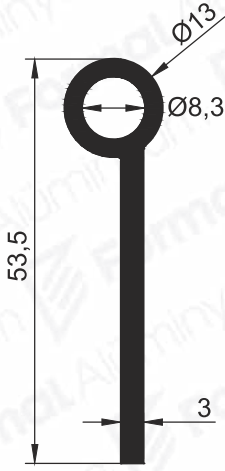

Pr.No: 9685
0,547 kg/m

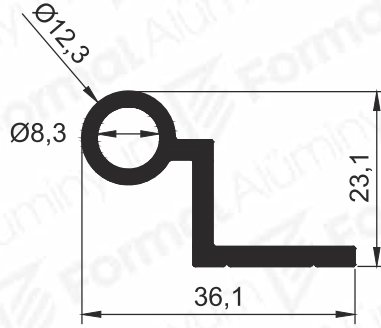

Pr.No: 9479
0,442 kg/m

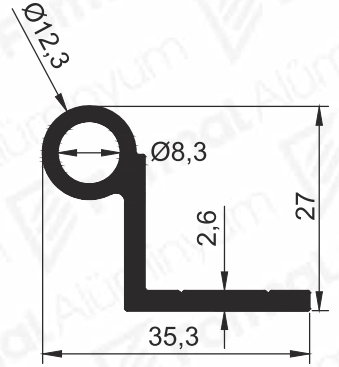

Pr.No: 9480
0,468 kg/m

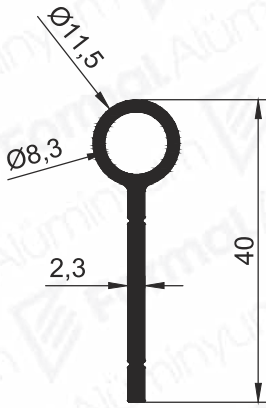

Pr.No: 2274
0,312 kg/m

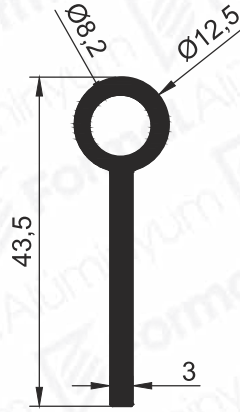

Pr.No: 8618
0,444 kg/m

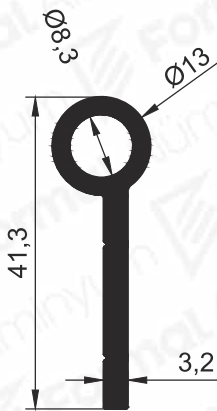

Pr.No: 9477
0,460 kg/m

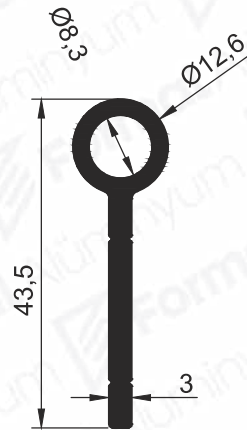

Pr.No: 9478
0,442 kg/m

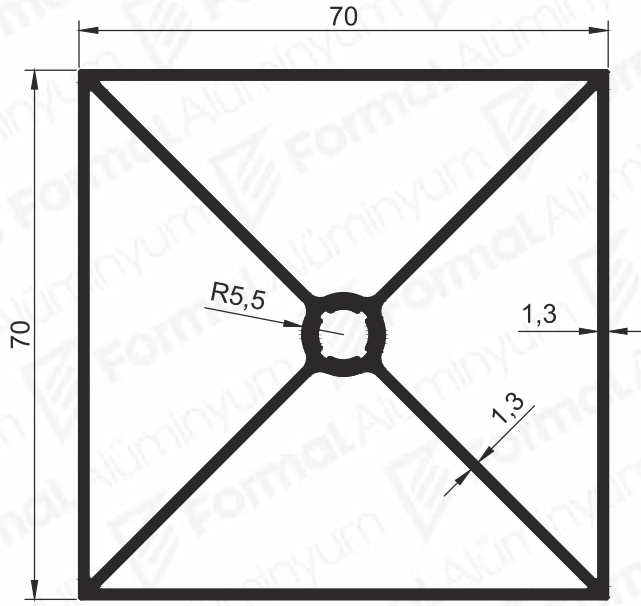

Pr.No: 9895
1,717 kg/m

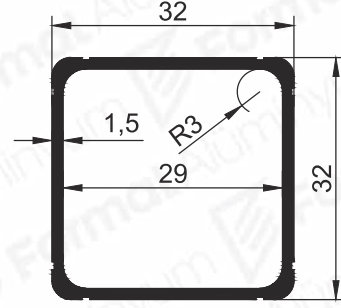

Pr.No: 3768
0,496 kg/m

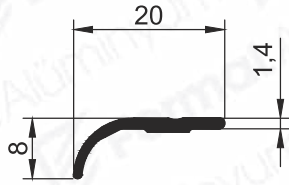

Pr.No: 9347
0,088 kg/m

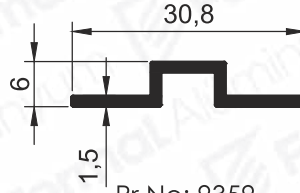

Pr.No: 9359
0,162 kg/m

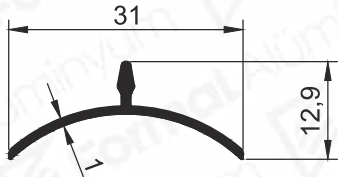

Pr.No: 9970
0,116 kg/m

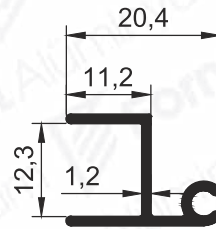

Pr.No: 9971
0,168 kg/m



Pr.No: 3678
0,715 kg/m

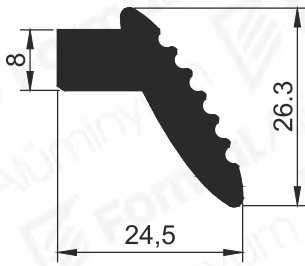

Pr.No: 8067
0,614 kg/m

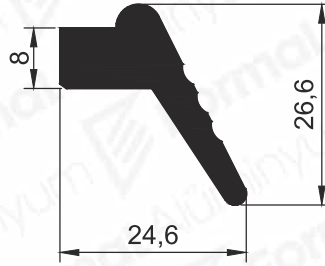

Pr.No: 8068
0,558 kg/m

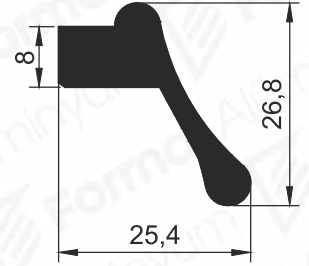

Pr.No: 8069
0,535 kg/m

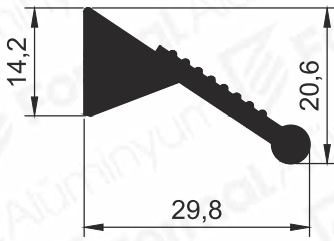

Pr.No: 8071
0,459 kg/m

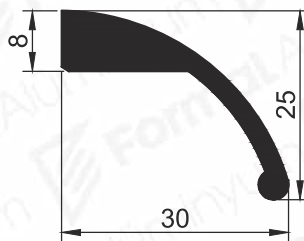

Pr.No: 8072
0,450 kg/m

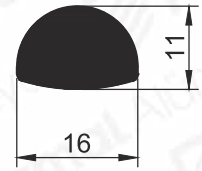

Pr.No: 8073
0,382 kg/m

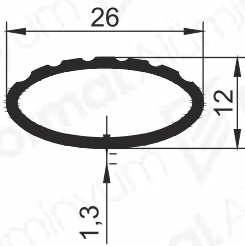

Pr.No: 8075
0,191 kg/m

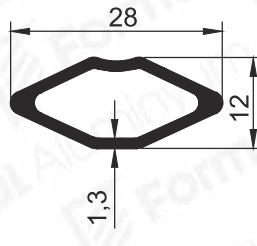

Pr.No: 8076
0,221 kg/m

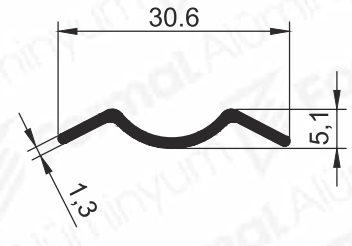

Pr.No: 8078
0,122 kg/m

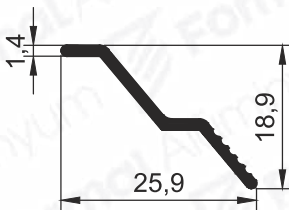

Pr.No: 8079
0,124 kg/m

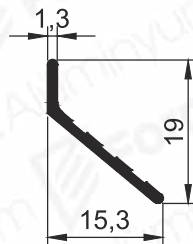

Pr.No: 8080
0,085 kg/m

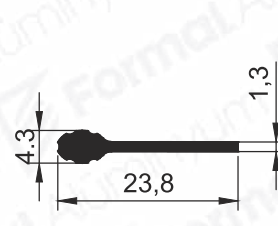

Pr.No: 8081
0,118 kg/m

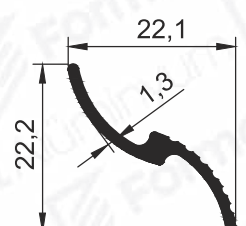

Pr.No: 8082
0,135 kg/m

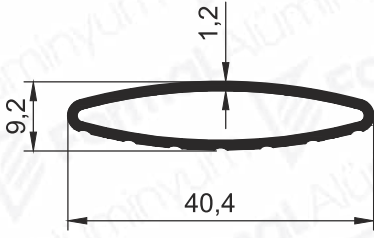

Pr.No: 9787
0,262 kg/m

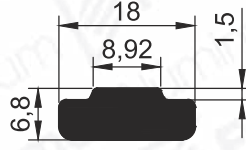

Pr.No: 9728
0,292 kg/m

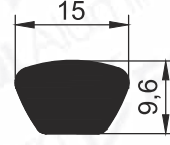

Pr.No: 9727
0,317 kg/m

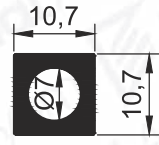

Pr.No: 9594
0,206 kg/m

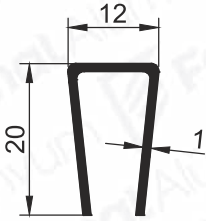

Pr.No: 9109
0,136 kg/m

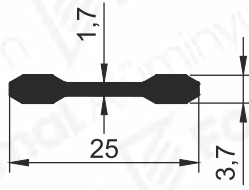

Pr.No: 8573
0,176 kg/m

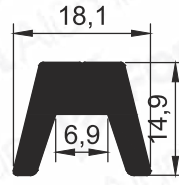

Pr.No: 9238
0,383 kg/m

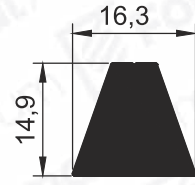

Pr.No: 9239
0,489 kg/m

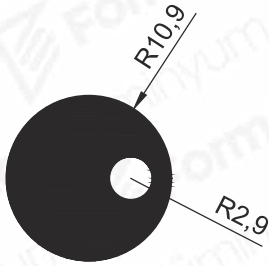

Pr.No: 8594
0,943 kg/m

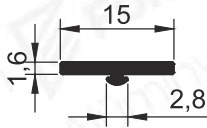

Pr.No: 2218
0,073 kg/m

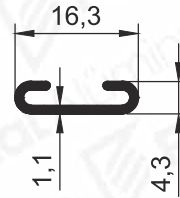

Pr.No: 8595
0,080 kg/m

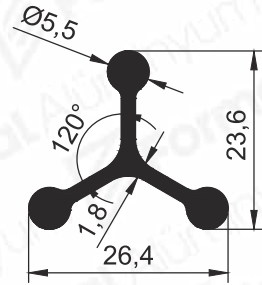

Pr.No: 8604
0,339 kg/m

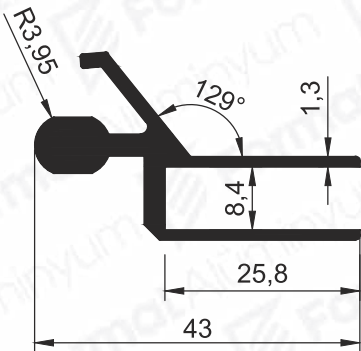

Pr.No: 1170
0,578 kg/m

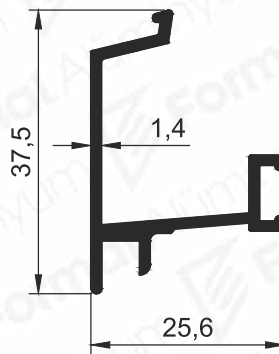

Pr.No: 8911
0,343 kg/m

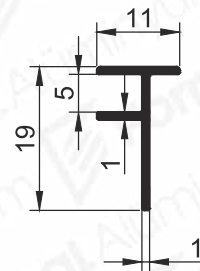

Pr.No: 1499
0,094 kg/m

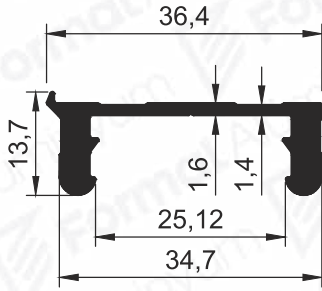

Pr.No: 1480
0,380 kg/m

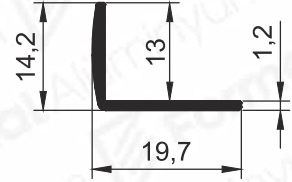

Pr.No: 9961
0,114 kg/m

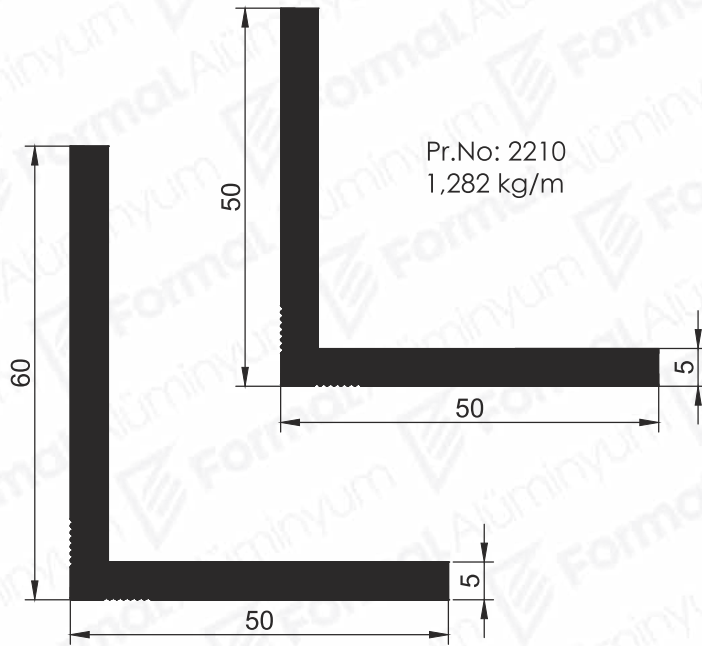

Pr.No: 2210
1,282 kg/m

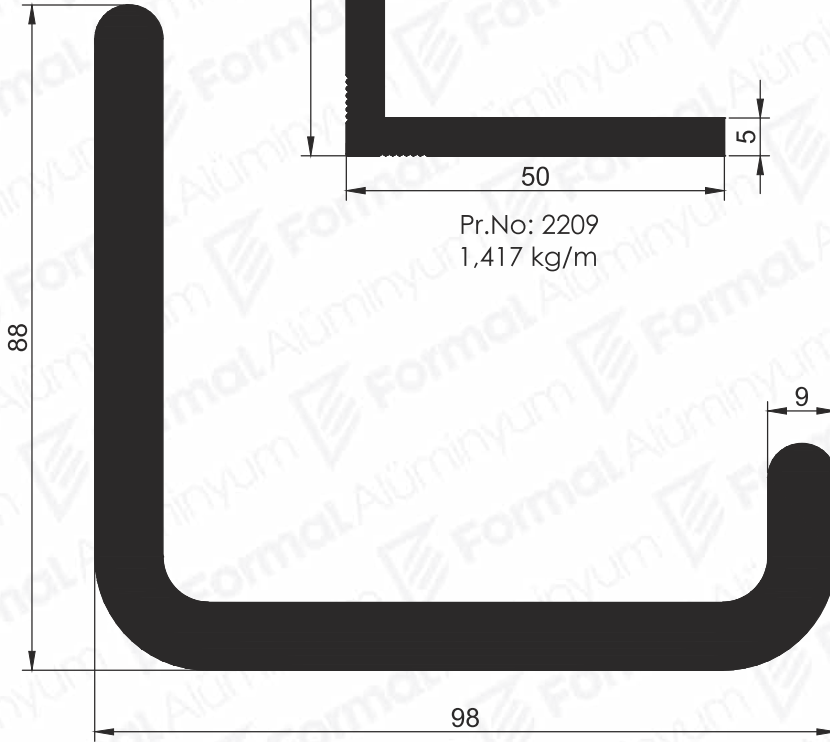

Pr.No: 2209
1,417 kg/m

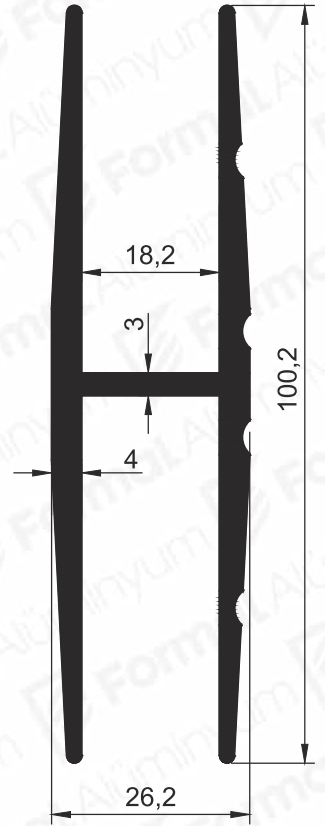

Pr.No: 9963
1,837 kg/m

Pr.No: 1324
4,562 kg/m

Sandalye profilleri

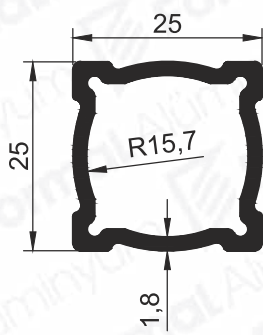

Pr.No: 1659
0,498 kg/m

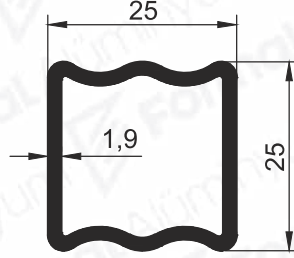

Pr.No: 9680
0,449 kg/m

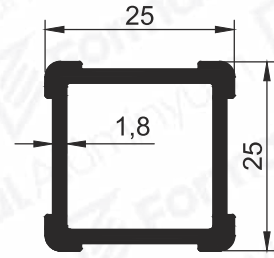

Pr.No: 9358
0,497 kg/m

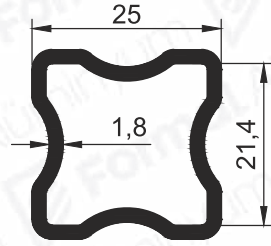

Pr.No: 8845
0,458 kg/m

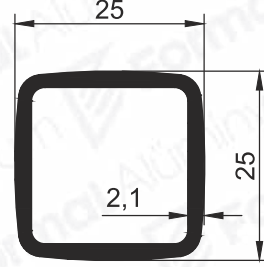

Pr.No: 9921
0,447 kg/m

Paspas profili

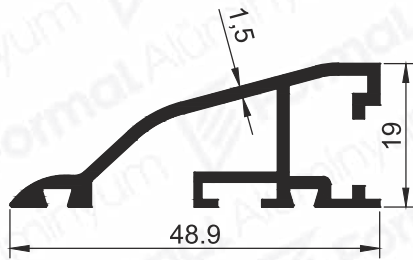

Pr.No: 8103
0,463 kg/m

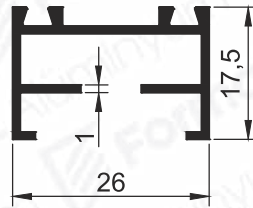

Pr.No: 8104
0,243 kg/m

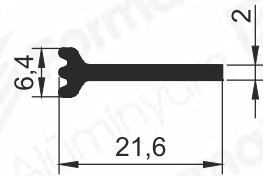

Pr.No: 8105
0,141 kg/m

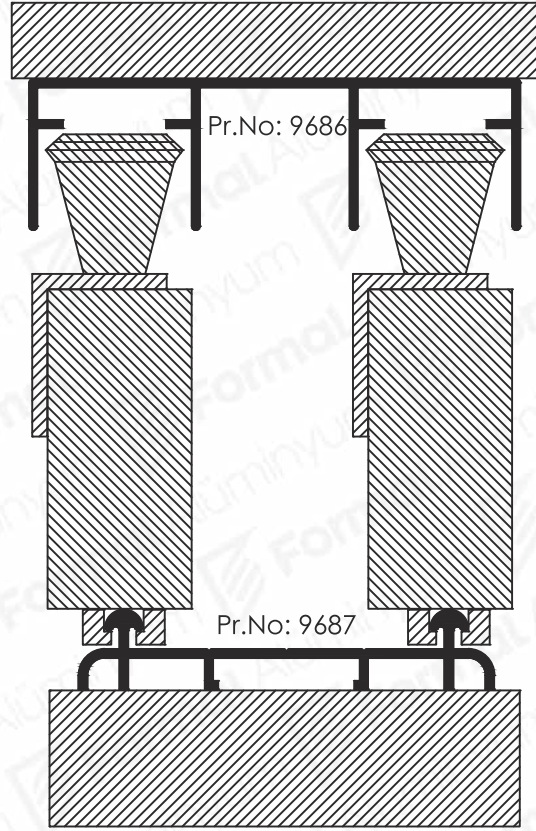

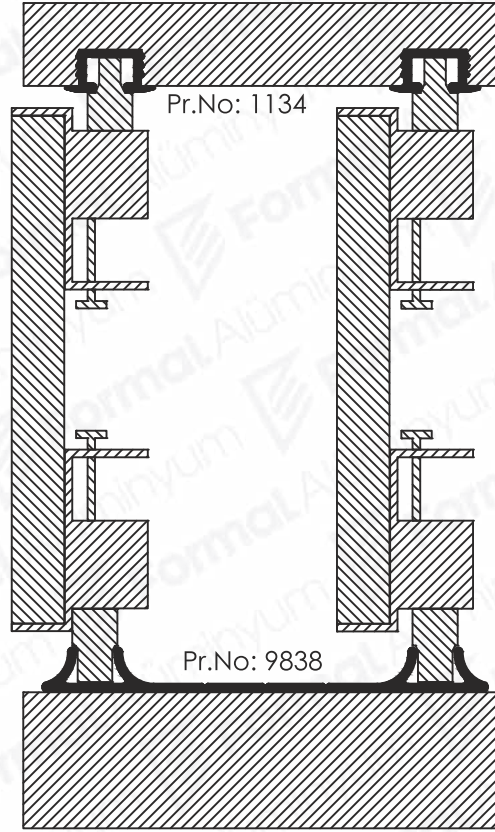

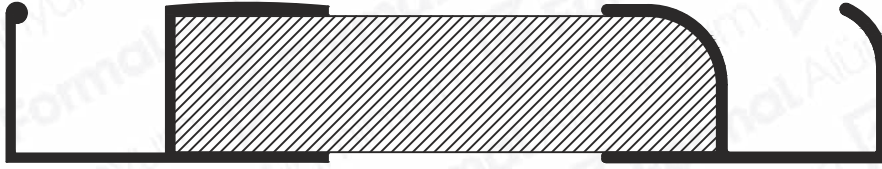

Pr.No: 9322

Pr.No: 8737

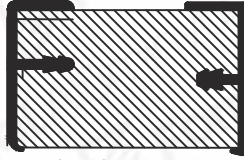

Pr.No: 9149

Pr.No: 9719



Pr.No: 1257

Pr.No: 8574

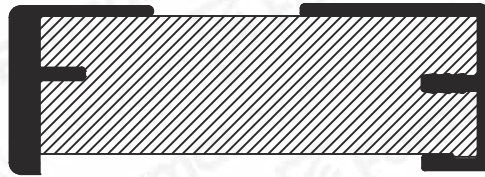

Pr.No: 8755

Pr.No: 9187

Pr.No: 8969

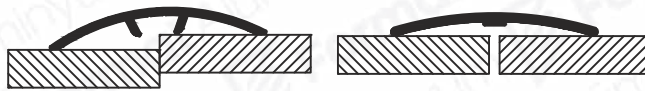

Pr.No: 9747

Pr.No: 8537



Pr.No: 8536

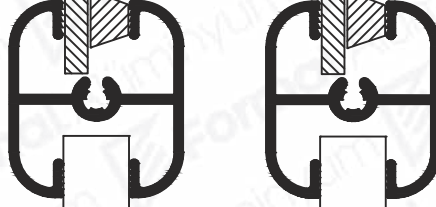

Pr.No: 9623

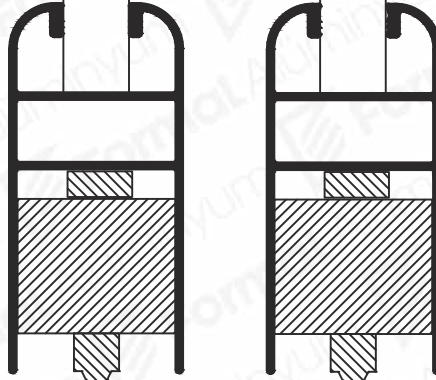

Pr.No: 9626

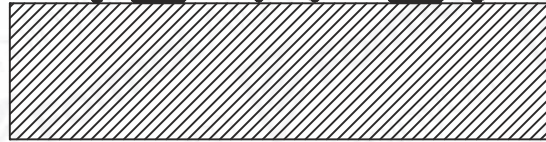

SUPPLIER
OF SECTORAL
LEADERS

Sektör Liderlerinin
Tedarikçisi

 **Formal Alüminyum**

Formal Alüminyum San. ve Tic. A.Ş.

O.S.B. 35. Cad. No: 27 38070 Kayseri / TÜRKİYE

T: +90 352 322 15 55 F: +90 352 322 15 65

444 9 258

www.formal.com.tr